



# KENSINGTON

WINDOW EXPRESSIONS™



Product Reference & Price Guide

## the honeycomb collection

# Kensington Honeycomb Shades

August 15, 2011

*Prices subject to change without notice.*



# THE BEST OF FORM... FUNCTION... BEAUTY... AND VERSATILITY.

*Honeycomb Shades offer all these features, making them the ideal choice to adorn any size or shape window. Enticing colors and fabrics combine with a host of specialty systems to harmonize with any decor in the home.*

- Honeycomb construction provides superior insulation and energy efficiency
- No visible cords or cord holes, reduces light leaks, and adds to the fashionable appeal
- Fabric available in wide widths to cover large expanses with no seams or overlaps
- Neutral white backing provides uniform appearance to the outside of the home
- 100% crisp polyester fabric repels dust and dirt, and is easy to clean and maintain
- Durable headrail and crash-proof cordlock ensures smooth operation



TABLE OF CONTENTS	
Fabrics and Light Control Options	4
Design Options	5
How To Order	6
Ascent Motorized Shade Specifications	7
<b>Shade Specifications &amp; Pricing</b>	<b>7-29</b>
• 1/2" Double Cell Translucent	8,9
• 3/4" Linen and 3/8" Texture Translucent	10, 11
• 3/8" Double Cell Translucent	12, 13
• 3/4" Single Cell Translucent	14, 15
• 3/4" Single Cell Blackout	16, 17
• 3/8" Single Cell Translucent	18, 19
• 1/2" Single Cell Translucent	20, 21
• 3/8" Single Cell Blackout and 3/8" Double Cell Blackout	22, 23
Longitude Specifications & Pricing	24-26
Ascent w/ RF Technology Motorized Specifications & Options	27, 28
Measuring Guidelines	29
Template Preparation Guidelines	29
Fabric Insulation/Light Transmission Data	30
Child Safety & Care & Cleaning	30
Mounting & Rail Measurements	31
Finished Dimensions	31
Limited Lifetime Warranty	31

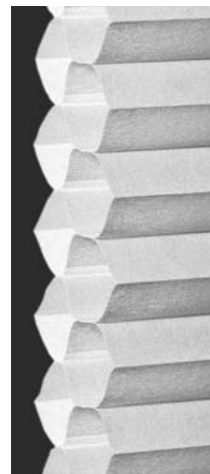

**DOUBLE CELL  
TRANSLUCENT**

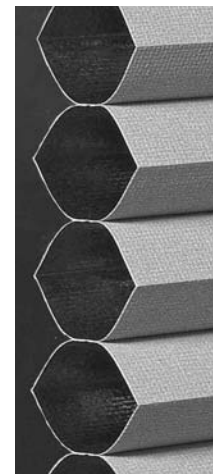

**SINGLE CELL  
BLACKOUT**

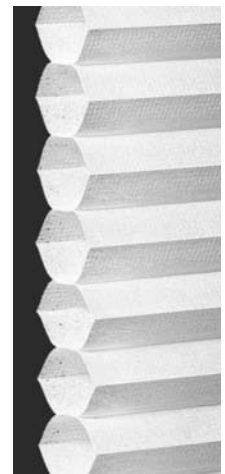

**SINGLE CELL  
TRANSLUCENT**

## FABRIC CHOICES

### 1/2" DOUBLE CELL TRANSLUCENT

- Fabric's suede-like appearance adds softness and warmth to any room.

### 3/4" LINEN AND 3/8" TEXTURE TRANSLUCENT

- Top quality fabric is soft and silky to the touch, yet durable and easy to maintain.

### 3/8" DOUBLE CELL TRANSLUCENT

- Wide choice of stylish colors, from subtle neutrals to bold, bright hues, suitable for any decorating taste.
- Beautiful, high quality fabric

### 3/4" SINGLE CELL TRANSLUCENT

- Beautiful fabric that will enhance any room in your home.

## FABRIC CHOICES *(continued)*

### 3/4" SINGLE CELL BLACKOUT

- Blocks out 99% of light to provide ultimate privacy and light control.

### 3/8" SINGLE CELL TRANSLUCENT

- High quality fabric that adds warmth and beauty to any home decor.

### 3/8" SINGLE CELL BLACKOUT

- Blocks out 99% of light providing complete privacy and light control

### 1/2" SINGLE CELL TRANSLUCENT

- Beautiful, high quality fabric

### 3/8" DOUBLE CELL BLACKOUT

- Blocks out 99% of light for the highest level of privacy and light control.

## PRIVACY AND LIGHT CONTROL OPTIONS

Honeycomb shades come in three fabric types, translucent, room darkening and blackout. Each offer a different degree of privacy and light control.

### TRANSLUCENT FABRICS

- Transmit filtered light with no view through shade.
- Provide moderate privacy.
- Available in 3/8" - 1/2" Double Cell and 3/8" - 1/2" - 3/4" Single Cell fabrics.

### BLACKOUT FABRIC

- Blocks 99% of outside light.
- Provides complete privacy. Complete light control.
- Available in 3/4" Single Cell, 3/8" Single Cell fabric and 3/8" Double Cell fabrics.



## DESIGN OPTIONS

### STANDARD RECTANGULAR

Traditional cord operated Honeycomb Shade that raises from the bottom up and stacks at the top.

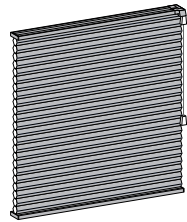

Standard Rectangular

### CONTINUOUS CORD LOOP

A continuous cord loop opens and closes the shade smoothly and evenly. Eliminates the traditional dangling cord, making for a neater appearance. A special clutch system keeps the shade at the desired height. Ideal option for larger shades.

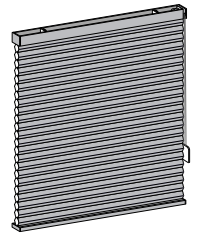

Continuous Cord

### TOP-DOWN/BOTTOM-UP

This shade can be opened from both the top and the bottom. Right and left hand controls move the middle and bottom rails to raise and lower the shade. This style is ideal for letting natural light in through the top while preserving privacy below.

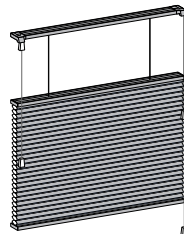

Top-Down/Bottom-Up

### TWO-ON-ONE HEADRAIL

For very large single windows or two large windows side by side, this specialty shade provides the appearance of a single shade, with two sections operating independently.

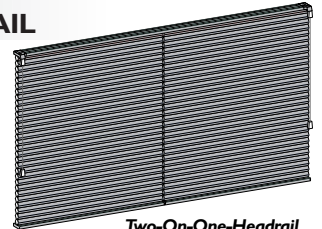

Two-On-One-Headrail

**Also available with Standard Continuous Cord System.**

### TOP-DOWN ONLY

Privacy is maintained while allowing natural light in, this shade stacks neatly at the bottom of the window when fully open. This top-down feature provides a unique look to a window.

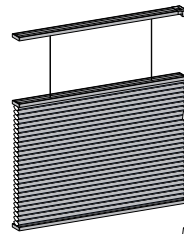

Top-Down Only

### DAY-NIGHT SHADE

This style shade utilizes two different fabrics on one shade. A translucent fabric is used on the top and a room darkening or blackout fabric on the bottom, connected by a moving rail. This shade provides a variety of light control and privacy options.



Day-Night Shade

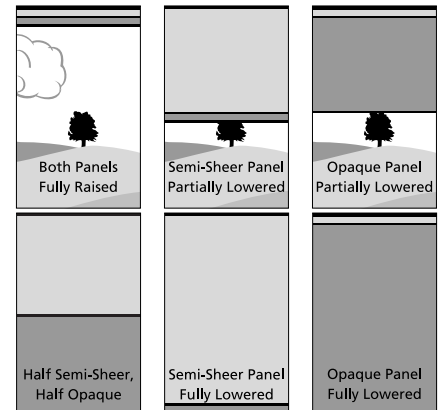

### ARCHES & QUARTER CIRCLES

#### STATIONARY ARCH

This classic starburst design has no moving rail.

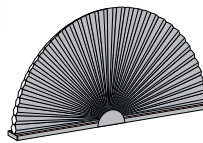

Stationary Arch

#### MOVEABLE ARCH

The starburst design fits perfect arch openings and is fully operable.

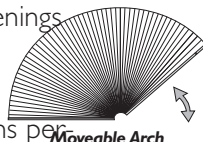

Moveable Arch

#### STATIONARY QUARTER CIRCLE

The shade has no moving rail and remains permanently opened.

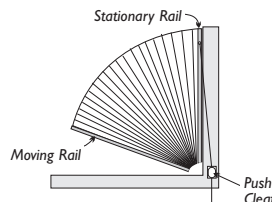

Moveable Quarter Circle

#### MOVEABLE QUARTER CIRCLE

This specialty shade has a moving rail for light control and fits quarter circle windows where the height equals the width.

### DELUXE CORDLESS LIFT SYSTEM

Deluxe cordless system eliminates the exposed cords and is easy to adjust by lifting or lowering the shade with a gentle push or pull on the bottom rail. Eliminates danger of dangling cords to children and pets. Also available in Top-Down/Bottom-Up

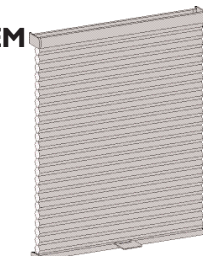

Deluxe Cordless Lift System

### ASCENT W/ RF TECHNOLOGY MOTORIZED SHADES

Perfect for hard-to-reach windows, the battery operated remote control system will allow you to control shades with the touch of a button. Available as Standard, the Ascent with RF Technology Motorized System eliminates dangling cords and the hazards associated for children and pets. For more details on this system refer to page 31. Also see shade size specifications for Ascent with RF Technology Systems on page 7.

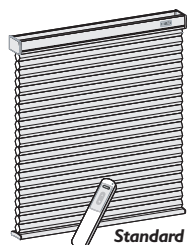

Standard

# How To ORDER

The total retail price for a Honeycomb Shade is determined by the following information:

- Fabric selection
- The size of the shade ordered
- Options requested

**FABRIC SELECTION** - Each fabric uses a separate price chart located in the pricing section, pages 8 through 27.

**SIZE OF SHADE** - On the appropriate price chart, the shade's **base price** is determined by the size of the shade.

- Round **UP** the shade's measured width and height to the nearest width and height dimensions on the chart.
- Locate the shade's base price - follow down the column under the shade's rounded-up width until it crosses the line of prices for the shade's rounded-up height. Where the two intersect is the shade's correct base price.

**REQUESTED OPTIONS** - Below each price chart is information for that fabric's available options. Add the appropriate **surcharges** to the shade's base price to arrive at the shade's total price.

**ORDERING TIPS** - Consider the following when ordering Honeycomb Shades:

- **Size Limitations:** Some options are only available in restricted sizes.
- **Day-Night Shade Fabric Restrictions:** Fabric combinations are limited to two fabric groups. Refer to the appropriate specifications page for details.
- **Continuous Cord Recommendations:** Large shades, within the boxed area of the price charts, are easier to operate using a continuous cord system.

**PRICING EXAMPLE** - Determine the final price for the following shade: (See Fig. 1 below.)

- **Fabric:** 1/2" Double Cell Translucent
- **Size:** 62" x 80"
- **Options:** Standard Continuous Cord System

1. Locate the appropriate price chart, **Price Group A1** on page 9.
2. Round **UP** the shade's measurements to the nearest width and height on the chart, **66" x 84"**.
3. Find the correct **base price**, where the rounded-up width price column crosses the rounded-up height price line..... **\$1343.00**
4. Add the **surcharge** for Standard Continuous Cord System, from the corresponding rounded-up width price column ..... **+198.00**
5. Add the two together for final price ..... **\$1541.00**

## PRICING EXAMPLE (Fig. 1)

HONEYCOMB SHADES													9			
1/2" DOUBLE CELL TRANSLUCENT												PRICE GROUP				
STANDARD RECTANGULAR												A1				
WIDTH TO:	24"	30"	36"	42"	48"	54"	60"	66"	72"	84"	96"	108"	120"	132"	144"	
HEIGHT TO:	36"	384	433	483	544	597	647	700	757	815	928	1048	1168	1272	1382	1480
	42"	406	466	520	588	646	718	774	83	896	1027	1158	1284	1406	1538	1644
	48"	426	493	569	639	705	767	843	914	985	1112	1232	1403	1546	1676	1815
	54"	466	524	607	678	759	826	909	983	1065	1208	1379	1523	1683	1825	1975
	60"	490	558	649	723	806	885	978	1060	1142	1303	1489	1644	1815	1972	2143
	66"	512	600	684	777	864	955	1036	1127	1220	1399	1588	1773	1948	2128	2298
	72"	541	627	722	818	914	1016	1102	1198	1301	1494	1700	1893	2082	2278	2457
	78"	566	661	757	872	968	1070	1168	1275	1377	1585	1803	2014	2222	2422	2621
	84"	588	688	788	898	1000	1100	1200	1300	1452	1663	1901	2114	2342	2555	2770
	90"	610	716	842	961	1070	1173	1279	1388	1529	1752	2011	2237	2476	2699	2925
	96"	640	747	872	989	1120	1229	1350	1477	1604	1837	2104	2342	2597	2834	3076
	108"	683	813	945	1078	1212	1347	1477	1619	1747	2021	2303	2575	2847	3119	3383
	120"	735	872	1019	1169	1315	1460	1599	1763	1899	2192	2509	2809	3101	3398	3687

*Continuous Cord System recommended for sizes within boxed area.*

STANDARD CONTINUOUS CORD SYSTEM SURCHARGES															
WIDTH TO:	24"	30"	36"	42"	48"	54"	60"	66"	72"	84"	96"	108"	120"	132"	144"
ADD:	135	144	159	167	173	177	180	198	202	215	232	244	256	271	283

DELUXE CORDLESS LIFT SYSTEM SURCHARGES													
WIDTH TO:	24"	30"	36"	42"	48"	54"	60"	66"	72"	84"	96"	108"	120"
ADD:	150	159	176	185	191	195	198	218	224	238	255	266	281

ASCENT W/ RF TECHNOLOGY MOTORIZED SYSTEM SURCHARGES															
WIDTH TO:	24"	30"	36"	42"	48"	54"	60"	66"	72"	84"	96"	108"	120"	132"	144"
ADD:	701	719	739	760	792	827	865	895	930	959	974	1027	1041	1056	1074

\* For option specifications and surcharges refer to page 31  
\* Remote Control: \$200 (Purchase at least one hand-held remote control per order)

OTHER SURCHARGES												
Two-On-One Headrail:	Price as two individual shades, add together, and add: ..... \$151.											
Two-On-One Headrail with Standard Continuous Cord:	Price as two individual shades, add together, add the Continuous Cord surcharges for each shade, and add: ..... \$151.											
Top-Down/Bottom-Up:	Price as a standard shade, and add: ..... \$204.											
Top-Down Only Shades:	Price as a standard shade, and add: ..... \$204.											
Day-Night Shades:	Price each fabric as a separate shade and add the two shades together.											
Top-Down/Bottom-Up Cordless Shades:	Add \$233 to the Standard Cordless Surcharge.											

ARCHES & QUARTER CIRCLES													PRICE GROUP
Stationary Arch	410	467	519	587	671	756	855	955	1074				A2
Movable Arch	607	683	766	862	967	1095	1216	1346	1467				
Stationary Quarter Circle	530	608	695	789	950								
Movable Quarter Circle	742	851	972	1105	1229								

\* A template is required for all Non-Perfect Stationary Arches. Movable Arches are only available on Perfect Arches, (height equals 1/2 of the width). For all Quarter Circles, the width must equal the height.  
\* For any shade requiring a template, there will be a template surcharge of \$151 added to the price of the shade.

## IMPORTANT ORDERING INFORMATION

In addition to the correct price, all orders must include the following information:

- Fabric selection
- Color name and color number
- All options requested
- Position of controls, left or right side
- Accurate measurements for the shade's width and height
- Additional required dimensions for specialty shape applications. **Template required.** (See pages 33)
- Type of mounting required:
  - Inside Mount (IB)
  - Outside Mount (OB)
  - End Mount (EM)
- Desired window/wall clearance
- Other options such as hold-down brackets

# ASCENT w/ RF TECHNOLOGY MOTORIZED SHADE SPECIFICATIONS

• Maximum width on an End-Mount Ascent shade is 65"

## ASCENT w/ RF TECHNOLOGY MAXIMUM HEIGHT CHART STANDARD

Width To:		20"	24"	30"	36"	42"	48"	54"	60"	66"	72"	78"	84"	90"	96"	102"	108"	114"	120"	132"	144"		
Height To:	3/8" Translucent	108"	108"	108"	108"	108"	108"	108"	108"	108"	108"	108"	108"	108"	108"	108"	108"	108"	108"	108"	108"	108"	
	3/8" Blackout	108"	108"	108"	108"	108"	108"	108"	108"	108"	108"	108"	108"	108"	108"	108"	108"	102"	102"	96"	84"		
	1/2" Double Cell	108"	108"	108"	108"	108"	108"	108"	108"	108"	108"	108"	108"	108"	108"	108"	108"	108"	108"	102"	84"		
	3/4" Translucent	108"	108"	108"	108"	108"	108"	108"	108"	108"	108"	108"	108"	108"	108"	108"	108"	108"	108"	108"	108"	96"	
	3/4" Blackout	108"	108"	108"	108"	108"	108"	108"	108"	108"	108"	108"	108"	108"	108"	108"	108"	108"	108"	108"	84"	84"	

## FABRICS AVAILABLE

- 1/2" Double Cell Translucent ..... AI
- 3/4" Single Cell Translucent ..... FI
- 3/4" Single Cell Blackout..... GI
- 3/8" Single Cell Translucent..... HI
- 3/8" Double Cell Blackout ..... JI

# 1/2" DOUBLE CELL TRANSLUCENT

SPECIFICATIONS • MINIMUMS / MAXIMUMS

## STANDARD RECTANGULAR:

SINGLE SHADE

**Minimum Size:** 12" w x 8" h

**Maximum Size:** 144" w x 120" h

## TWO-ON-ONE HEADRAIL:

**Minimum Size:** 16" w x 8" h

**Maximum Size:** 144" w x 120" h

## TWO-ON-ONE HEADRAIL WITH STANDARD CONTINUOUS CORD:

**Minimum Size:** 44" w x 8" h

**Maximum Size:** 144" w x 120" h

## TOP-DOWN / BOTTOM-UP:

**Minimum Size:** 12" w x 12" h

**Maximum Size:** 72" w x 96" h

## TOP-DOWN ONLY:

**Minimum Size:** 12" w x 12" h

**Maximum Size:** 72" w x 96" h

## DELUXE CORDLESS AND TOP-DOWN/BOTTOM-URLIFT SYSTEM:

SINGLE SHADE

**Minimum Size:** 18" w x 8" h

**Maximum Size:** 120" w x 84" h

## STANDARD CONTINUOUS CORD:

SINGLE SHADE

**Minimum Size:** 22" w x 8" h

**Maximum Size:** 144" w x 120" h

## DAY-NIGHT SHADES:\*

**Minimum Size:** 12" w x 18" h

**Maximum Size:** 72" w x 96" h

\* 1/2" Double Cell Translucent fabric can only be combined with the following fabrics:

- 1/2" Double Cell Translucent
- 3/4" Single Cell Translucent
- 3/4" Single Cell Blackout

## STATIONARY ARCH:

**Minimum Size:** 18" w x 9" h

**Maximum Size:** 72" w x 36" h

## MOVEABLE ARCH:\*

PERFECT ARCH ONLY

**Minimum Size:** 18" w x 9" h

**Maximum Size:** 72" w x 36" h

\* Height must equal 1/2 width

## STATIONARY QUARTER CIRCLE:\*

**Minimum Size:** 9" w x 9" h

**Maximum Size:** 48" w x 48" h

\* Height must equal width

## MOVEABLE QUARTER CIRCLE:\*

**Minimum Size:** 9" w x 9" h

**Maximum Size:** 48" w x 48" h

\* Height must equal width

## ASCENT W/ RF TECHNOLOGY MOTORIZED SHADES:

**Minimum Size:** 19 1/2" w x 8" h

**Maximum Size:** \*For Standard Shade refer to the maximum height charts on page 7.

## STACKING HEIGHTS

- Drop refers to shade fully extended.
- Stack refers to shade fully raised.
- Measurements do not include headrail and bottom rail.

## STANDARD RECTANGULAR:

STACKING HEIGHTS

**Drop:** 48" 72" 84" 144"

**Stack:** 5/8" 1" 1 1/8" 1 5/8"

# 1/2" DOUBLE CELL TRANSLUCENT

## STANDARD RECTANGULAR

PRICE GROUP  
**A1**

WIDTH TO:		24"	30"	36"	42"	48"	54"	60"	66"	72"	84"	96"	108"	120"	132"	144"
HEIGHT TO:	36"	384	433	483	544	597	647	700	765	815	928	1048	1168	1272	1382	1480
	42"	406	466	520	588	646	718	774	843	896	1027	1158	1284	1406	1538	1644
	48"	436	493	569	639	705	767	843	914	983	1112	1272	1403	1546	1676	1815
	54"	466	524	607	678	759	826	909	983	1065	1208	1379	1523	1683	1825	1975
	60"	490	558	649	723	806	885	978	1060	1142	1303	1489	1644	1815	1972	2143
	66"	512	600	684	777	864	955	1036	1137	1220	1399	1588	1773	1948	2128	2298
	72"	541	627	722	818	914	1016	1105	1208	1301	1494	1700	1893	2082	2278	2457
	78"	566	661	757	872	968	1070	1168	1284	1377	1585	1803	2014	2222	2422	2621
	84"	581	695	799	902	1019	1119	1230	1343	1452	1663	1901	2114	2342	2555	2770
	90"	610	716	842	951	1070	1173	1299	1413	1529	1752	2011	2237	2476	2699	2935
	96"	640	747	872	989	1120	1229	1350	1477	1604	1837	2104	2342	2597	2834	3076
	108"	683	813	945	1078	1212	1347	1477	1619	1747	2021	2303	2575	2847	3119	3383
120"	735	872	1019	1169	1315	1460	1599	1763	1899	2192	2509	2809	3101	3398	3687	

Continuous Cord System recommended for sizes within boxed area.

### STANDARD CONTINUOUS CORD SYSTEM SURCHARGES

WIDTH TO: >	24"	30"	36"	42"	48"	54"	60"	66"	72"	84"	96"	108"	120"	132"	144"
ADD:	135	144	159	167	173	177	180	198	202	215	232	244	256	271	283

### DELUXE CORDLESS LIFT SYSTEM SURCHARGES

WIDTH TO: >	24"	30"	36"	42"	48"	54"	60"	66"	72"	84"	96"	108"	120"
ADD:	150	159	176	185	191	195	198	218	224	238	255	266	281

### ASCENT W/ RF TECHNOLOGY MOTORIZED SYSTEM SURCHARGES

WIDTH TO: >	24"	30"	36"	42"	48"	54"	60"	66"	72"	84"	96"	108"	120"	132"	144"
ADD:	701	719	739	760	792	827	865	895	930	959	974	1027	1041	1056	1074

- For option specifications and surcharges refer to page 31
- Remote Control: \$200 (Purchase at least one hand-held remote control per order.)

### OTHER SURCHARGES

- Two-On-One Headrail:** ..... Price as **two** individual shades, add together, and add... \$151.
- Two-On-One Headrail with Standard Continuous Cord:** ..... Price as **two** individual shades, add together, add the Continuous Cord surcharges for **each** shade, and add... \$151.
- Top-Down/Bottom-Up:** ..... Price as a standard shade, and add... \$204.
- Top-Down Only Shades:** ..... Price as a standard shade, and add... \$204.
- Day-Night Shades:** ..... Price **each** fabric as a separate shade and add the **two** shades together.
- Top-Down/Bottom-Up Cordless Shades:** ..... Add \$233 to the Standard Cordless Surcharge.

## ARCHES & QUARTER CIRCLES

WIDTH TO: >	24"	30"	36"	42"	48"	54"	60"	66"	72"	PRICE GROUP
<b>Stationary Arch</b>	410	467	519	587	671	756	855	955	1074	<b>A2</b>
<b>Moveable Arch</b>	607	683	766	862	967	1095	1216	1346	1467	
<b>Stationary Quarter Circle</b>	530	608	695	789	950					
<b>Moveable Quarter Circle</b>	742	851	972	1105	1329					

A template is required for all Non-perfect Stationary Arches.\* Moveable Arches are only available as Perfect Arches, (height equals 1/2 of the width). For all Quarter Circles, the width must equal the height.

\*For any shade requiring a template, there will be a template surcharge of \$151 added to the price of the shade.

## 3/4" SINGLE CELL LINEN TRANSLUCENT & 3/8" SINGLE CELL TEXTURE TRANSLUCENT

### SPECIFICATIONS • MINIMUMS / MAXIMUMS

#### STANDARD RECTANGULAR: SINGLE SHADE

<b>Minimum Size:</b>	12" w x 8" h
<b>Maximum Size:</b>	144" w x 120" h

#### TWO-ON-ONE HEADRAIL:

<b>Minimum Size:</b>	16" w x 8" h
<b>Maximum Size:</b>	144" w x 120" h

#### TWO-ON-ONE HEADRAIL WITH STANDARD CONTINUOUS CORD:

<b>Minimum Size:</b>	44" w x 8" h
<b>Maximum Size:</b>	144" w x 120" h

#### TOP-DOWN / BOTTOM-UP:

<b>Minimum Size:</b>	12" w x 12" h
<b>Maximum Size:</b>	72" w x 96" h

#### TOP-DOWN ONLY:

<b>Minimum Size:</b>	12" w x 12" h
<b>Maximum Size:</b>	72" w x 96" h

#### DELUXE CORDLESS LIFT SYSTEM:

<b>Minimum Size:</b>	18" w x 8" h
<b>Maximum Size:</b>	120" w x 84" h

#### STANDARD CONTINUOUS CORD: SINGLE SHADE

<b>Minimum Size:</b>	22" w x 8" h
<b>Maximum Size:</b>	144" w x 120" h

#### DAY-NIGHT SHADES:

<b>Minimum Size:</b>	12" w x 18" h
<b>Maximum Size:</b>	72" w x 96" h

#### ASCENT w/ RF TECHNOLOGY MOTORIZED SHADES:

<b>Minimum Size:</b>	18" w x 8" h
<b>Maximum Size:</b>	144" w x 96" h

#### STATIONARY ARCH:

<b>Minimum Size:</b>	18" w x 9" h
<b>Maximum Size:</b>	72" w x 36" h

#### STATIONARY QUARTER CIRCLE:\*

<b>Minimum Size:</b>	9" w x 9" h
<b>Maximum Size:</b>	48" w x 48" h

\* Height must equal width

### STACKING HEIGHTS

- Drop refers to shade fully extended.
- Stack refers to shade fully raised.
- Measurements do not include headrail and bottom rail.

#### STANDARD RECTANGULAR: STACKING HEIGHTS

<b>Drop:</b>	48"	72"	84"	96"
<b>Stack:</b>	2 1/2"	3/4"	1"	1 1/4"

# 3/4" SINGLE CELL LINEN TRANSLUCENT & 3/8" SINGLE CELL TEXTURE TRANSLUCENT

PRICE GROUP  
**B1**

## STANDARD RECTANGULAR

WIDTH TO:		24"	30"	36"	42"	48"	54"	60"	66"	72"	84"	96"
HEIGHT TO:	36"	416	470	534	600	664	723	784	840	906	1040	1170
	42"	445	509	580	656	723	790	862	929	1000	1148	1298
	48"	476	550	628	708	784	861	934	1015	1095	1256	1420
	54"	505	584	673	758	842	926	1009	1104	1187	1362	1545
	60"	539	622	722	809	900	997	1087	1186	1278	1472	1665
	66"	572	664	767	864	965	1067	1162	1268	1370	1576	1792
	72"	601	698	809	917	1026	1133	1242	1354	1462	1684	1918
	78"	628	737	853	964	1089	1198	1318	1437	1556	1790	2037
	84"	651	769	895	1015	1145	1258	1384	1509	1631	1879	2143
	90"	683	806	939	1067	1201	1328	1456	1592	1729	1993	2264
	96"	708	839	976	1114	1254	1387	1526	1667	1804	2085	2376
	108"	769	909	1065	1214	1372	1518	1670	1826	1981	2289	2607
120"	822	983	1153	1318	1492	1654	1820	1990	2154	2492	2838	

### STANDARD CONTINUOUS CORD SYSTEM SURCHARGES

WIDTH TO: >	24"	30"	36"	42"	48"	54"	60"	66"	72"	84"	96"
ADD:	135	144	159	167	173	177	180	198	202	215	232

### DELUXE CORDLESS LIFT SYSTEM SURCHARGES

WIDTH TO: >	24"	30"	36"	42"	48"	54"	60"	66"	72"	84"	96"	108"	120"
ADD:	150	159	176	185	191	195	198	218	224	238	255	266	281

### ASCENT W/ RF TECHNOLOGY MOTORIZED SYSTEM SURCHARGES

WIDTH TO: >	24"	30"	36"	42"	48"	54"	60"	66"	72"	84"	96"	108"	120"	132"	144"
ADD:	701	719	739	760	792	827	865	895	930	959	974	1027	1041	1056	1074

- For option specifications and surcharges refer to page 31
- Remote Control: \$200 (Purchase at least one hand-held remote control per order.)

### OTHER SURCHARGES

- Two-On-One Headrail:** ..... Price as **two** individual shades, add together, and add... \$151.
- Two-On-One Headrail with Standard Continuous Cord:** ..... Price as **two** individual shades, add together, add the Continuous Cord surcharges for **each** shade, and add... \$151.
- Top-Down/Bottom-Up:** ..... Price as a standard shade, and add... \$204.
- Top-Down Only Shades:** ..... Price as a standard shade, and add... \$204.
- Day-Night Shades:** ..... Price **each** fabric as a separate shade and add the **two** shades together.
- Top-Down/Bottom-Up Cordless Shades:** ..... Add \$233 to the Standard Cordless Surcharge.

## ARCHES & QUARTER CIRCLES

WIDTH TO: >	24"	30"	36"	42"	48"	54"	60"	PRICE GROUP
<b>Stationary Arch</b>	480	548	625	714	856	978	1109	<b>B2</b>
<b>Stationary Quarter Circle</b>	623	714						

A template is required for all Non-perfect Stationary Arches\*. For all Quarter Circles, the width must equal the height.

\*For any shade requiring a template, there will be a template surcharge of \$151 added to the price of the shade.

**3/8" DOUBLE CELL TRANSLUCENT**

SPECIFICATIONS • MINIMUMS / MAXIMUMS

**STANDARD RECTANGULAR:**

SINGLE SHADE

<b>Minimum Size:</b>	12" w x 8" h
<b>Maximum Size:</b>	96" w x 120" h

**TWO-ON-ONE HEADRAIL:**

<b>Minimum Size:</b>	16" w x 8" h
<b>Maximum Size:</b>	144" w x 120" h

**TWO-ON-ONE HEADRAIL  
WITH STANDARD  
CONTINUOUS CORD:**

<b>Minimum Size:</b>	44" w x 8" h
<b>Maximum Size:</b>	144" w x 120" h

**TOP-DOWN / BOTTOM-UP:**

<b>Minimum Size:</b>	12" w x 12" h
<b>Maximum Size:</b>	72" w x 96" h

**TOP-DOWN ONLY:**

<b>Minimum Size:</b>	12" w x 12" h
<b>Maximum Size:</b>	72" w x 96" h

**ASCENT W/ RF TECHNOLOGY  
MOTORIZED SHADES:**

NOT AVAILABLE WITH THIS FABRIC

**DELUXE CORDLESS AND TOP-  
DOWN/BOTTOM-UP LIFT  
SYSTEM:**

SINGLE SHADE

<b>Minimum Size:</b>	18" w x 8" h
<b>Maximum Size:</b>	72" w x 84" h

**STANDARD  
CONTINUOUS CORD:**

SINGLE SHADE

<b>Minimum Size:</b>	22" w x 8" h
<b>Maximum Size:</b>	96" w x 120" h

**DAY-NIGHT SHADES:\***

<b>Minimum Size:</b>	12" w x 18" h
<b>Maximum Size:</b>	72" w x 96" h

\* 3/8" Double Cell Translucent fabric can only be combined with the following fabrics:

- 3/8" Double Cell Translucent
- 3/8" Single Cell Translucent
- 1/2" Single Cell Translucent
- 3/8" Single Cell Blackout
- Bottom Panel Only

**STATIONARY ARCH:**

<b>Minimum Size:</b>	18" w x 9" h
<b>Maximum Size:</b>	72" w x 36" h

**MOVEABLE ARCH:\***

PERFECT ARCH ONLY

<b>Minimum Size:</b>	18" w x 9" h
<b>Maximum Size:</b>	72" w x 36" h

\* Height must equal 1/2 width

**STATIONARY QUARTER CIRCLE:\***

<b>Minimum Size:</b>	9" w x 9" h
<b>Maximum Size:</b>	48" w x 48" h

\* Height must equal width

**MOVEABLE QUARTER CIRCLE:\***

<b>Minimum Size:</b>	9" w x 9" h
<b>Maximum Size:</b>	48" w x 48" h

\* Height must equal width

**STACKING HEIGHTS**

- Drop refers to shade fully extended.
- Stack refers to shade fully raised.
- Measurements do not include headrail and bottom rail.

**STANDARD RECTANGULAR:**

STACKING HEIGHTS

<b>Drop:</b>	48"	72"	84"	96"
<b>Stack:</b>	1 1/4"	1 3/4"	2"	2 1/4"

# 3/8" DOUBLE CELL TRANSLUCENT

## STANDARD RECTANGULAR

PRICE GROUP  
**C1**

WIDTH TO:		24"	30"	36"	42"	48"	54"	60"	66"	72"	84"	96"
HEIGHT TO:	36"	338	382	434	487	538	587	636	682	735	844	950
	42"	361	413	470	533	587	642	700	755	812	932	1053
	48"	386	446	509	575	636	699	759	824	888	1020	1152
	54"	410	474	547	615	683	752	819	897	964	1106	1254
	60"	438	505	586	657	731	809	883	962	1038	1194	1352
	66"	464	538	622	702	784	866	943	1029	1112	1279	1455
	72"	488	566	657	745	833	919	1008	1099	1187	1367	1557
	78"	509	598	692	782	884	972	1070	1166	1262	1453	1653
	84"	529	623	727	824	929	1021	1123	1225	1324	1526	1739
	90"	554	654	762	866	975	1078	1181	1292	1403	1618	1837
	96"	575	681	792	904	1018	1126	1239	1353	1465	1693	1929
	108"	623	738	865	985	1113	1233	1356	1483	1608	1858	2116
120"	667	798	936	1070	1211	1343	1477	1615	1749	2022	2304	

Continuous Cord System recommended for sizes within boxed area.

### STANDARD CONTINUOUS CORD SYSTEM SURCHARGES

WIDTH TO: >	24"	30"	36"	42"	48"	54"	60"	66"	72"	84"	96"
ADD:	135	144	159	167	173	177	180	198	202	215	232

### DELUXE CORDLESS LIFT SYSTEM SURCHARGES

WIDTH TO: >	24"	30"	36"	42"	48"	54"	60"	66"	72"
ADD:	150	159	176	185	191	195	198	218	224

### OTHER SURCHARGES

- Two-On-One Headrail:** ..... Price as **two** individual shades, add together, and add... \$151.
- Two-On-One Headrail with Standard Continuous Cord:** ..... Price as **two** individual shades, add together, add the Continuous Cord surcharges for **each** shade, and add... \$151.
- Top-Down/Bottom-Up:** ..... Price as a standard shade, and add... \$204.
- Top-Down Only Shades:** ..... Price as a standard shade, and add... \$204.
- Day-Night Shades:** ..... Price **each** fabric as a separate shade and add the **two** shades together.

### ARCHES & QUARTER CIRCLES

WIDTH TO: >	24"	30"	36"	42"	48"	54"	60"	66"	72"	PRICE GROUP
<b>Stationary Arch</b>	389	445	508	579	695	794	900	1017	1142	<b>C2</b>
<b>Moveable Arch</b>	558	630	718	816	974	1092	1229	1375	1538	
<b>Stationary Quarter Circle</b>	506	579	661	753	858					
<b>Moveable Quarter Circle</b>	695	789	895	1011	1142					

A template is required for all Non-perfect Stationary Arches.\* Stationary and Moveable Arches are only available as Perfect Arches, (height equals 1/2 of the width). For all Quarter Circles, the width must equal the height.

\*For any shade requiring a template, there will be a template surcharge of \$151 added to the price of the shade.

## 3/4" SINGLE CELL TRANSLUCENT

SPECIFICATIONS • MINIMUMS / MAXIMUMS

### STANDARD RECTANGULAR:

SINGLE SHADE

**Minimum Size:** 12" w x 8" h

**Maximum Size:** 144" w x 120" h

### TWO-ON-ONE HEADRAIL:

**Minimum Size:** 12" w x 8" h

**Maximum Size:** 144" w x 120" h

### TWO-ON-ONE HEADRAIL WITH STANDARD CONTINUOUS CORD:

**Minimum Size:** 44" w x 8" h

**Maximum Size:** 144" w x 120" h

### TOP-DOWN / BOTTOM-UP:

**Minimum Size:** 12" w x 12" h

**Maximum Size:** 72" w x 96" h

### TOP-DOWN ONLY:

**Minimum Size:** 12" w x 12" h

**Maximum Size:** 72" w x 96" h

### DELUXE CORDLESS AND TOP- DOWN/BOTTOM-UP LIFT SYSTEM:

SINGLE SHADE

**Minimum Size:** 18" w x 8" h

**Maximum Size:** 120" w x 84" h

### STANDARD CONTINUOUS CORD:

SINGLE SHADE

**Minimum Size:** 22" w x 8" h

**Maximum Size:** 144" w x 120" h

### DAY-NIGHT SHADES:\*

**Minimum Size:** 12" w x 18" h

**Maximum Size:** 72" w x 96" h

\* 3/4" Single Cell Translucent fabric can only be combined with the following fabrics:

- 1/2" Double Cell Translucent
- 3/4" Single Cell Translucent
- 3/4" Single Cell Blackout

### STATIONARY ARCH:

**Minimum Size:** 18" w x 9" h

**Maximum Size:** 72" w x 36" h

### MOVEABLE ARCH:\*

PERFECT ARCH ONLY

**Minimum Size:** 18" w x 9" h

**Maximum Size:** 72" w x 36" h

\* Height must equal 1/2 width

### STATIONARY QUARTER CIRCLE:\*

**Minimum Size:** 9" w x 9" h

**Maximum Size:** 48" w x 48" h

\* Height must equal width

### MOVEABLE QUARTER CIRCLE:\*

**Minimum Size:** 9" w x 9" h

**Maximum Size:** 48" w x 48" h

\* Height must equal width

### ASCENT W/ RF TECHNOLOGY MOTORIZED SHADES:

**Minimum Size:** 19 1/2" w x 8" h

**Maximum Size:** \*For Standard Shade refer to the maximum height charts on page 7.

### LONGITUDE VERTICAL SHADES:

**Minimum Size:** 12" w x 24" h

**Maximum Size:** 168" w x 120" h

\*Please see page 29 for Longitude pricing and additional information.

### STACKING HEIGHT

- Drop refers to shade fully extended.
- Stack refers to shade fully raised.
- Measurements do not include headrail and bottom rail.

### STANDARD RECTANGULAR:

STACKING HEIGHTS

**Drop:** 48" 72" 84" 144"

**Stack:** 1/4" 1/2" 3/4" 1 1/4"

# 3/4" SINGLE CELL TRANSLUCENT

## STANDARD RECTANGULAR

PRICE GROUP  
**F1**

WIDTH TO:		24"	30"	36"	42"	48"	54"	60"	66"	72"	84"	96"	108"	120"	132"	144"
HEIGHT TO:	36"	384	433	483	544	597	647	700	765	815	928	1048	1168	1272	1382	1480
	42"	406	466	520	588	646	718	774	843	896	1027	1158	1284	1406	1538	1644
	48"	436	493	569	639	705	767	843	914	983	1112	1272	1403	1546	1676	1815
	54"	466	524	607	678	759	826	909	983	1065	1208	1379	1523	1683	1825	1975
	60"	490	558	649	723	806	885	978	1060	1142	1303	1489	1644	1815	1972	2143
	66"	512	600	684	777	864	955	1036	1137	1220	1399	1588	1773	1948	2128	2298
	72"	541	627	722	818	914	1016	1105	1208	1301	1494	1700	1893	2082	2278	2457
	78"	566	661	757	872	968	1070	1168	1284	1377	1585	1803	2014	2222	2422	2621
	84"	581	695	799	902	1019	1119	1230	1343	1452	1663	1901	2114	2342	2555	2770
	90"	610	716	842	951	1070	1173	1299	1413	1529	1752	2011	2237	2476	2699	2935
	96"	640	747	872	989	1120	1229	1350	1477	1604	1837	2104	2342	2597	2834	3076
	108"	683	813	945	1078	1212	1347	1477	1619	1747	2021	2303	2575	2847	3119	3383
120"	735	872	1019	1169	1315	1460	1599	1763	1899	2192	2509	2809	3101	3398	3687	

Continuous Cord System recommended for sizes within boxed area.

### STANDARD CONTINUOUS CORD SYSTEM SURCHARGES

WIDTH TO: >	24"	30"	36"	42"	48"	54"	60"	66"	72"	84"	96"	108"	120"	132"	144"
ADD:	135	144	159	167	173	177	180	198	202	215	232	244	256	271	283

### DELUXE CORDLESS LIFT SYSTEM SURCHARGES

WIDTH TO: >	24"	30"	36"	42"	48"	54"	60"	66"	72"	84"	96"	108"	120"
ADD:	150	159	176	185	191	195	198	218	224	238	255	266	281

### ASCENT W/ RF TECHNOLOGY MOTORIZED SYSTEM SURCHARGES

WIDTH TO: >	24"	30"	36"	42"	48"	54"	60"	66"	72"	84"	96"	108"	120"	120"	120"
ADD:	701	719	739	760	792	827	865	895	930	959	974	1027	1041	1056	1074

- For option specifications and surcharges refer to page 31
- Remote Control: \$200 (Purchase at least one hand-held remote control per order.)

### OTHER SURCHARGES

- Two-On-One Headrail:** ..... Price as **two** individual shades, add together, and add... \$151.
- Two-On-One Headrail with Standard Continuous Cord:** ..... Price as **two** individual shades, add together, add the Continuous Cord surcharges for **each** shade, and add... \$151.
- Top-Down/Bottom-Up:** ..... Price as a standard shade, and add... \$204.
- Top-Down Only Shades:** ..... Price as a standard shade, and add... \$204.
- Day-Night Shades:** ..... Price **each** fabric as a separate shade and add the **two** shades together.
- Top-Down/Bottom-Up Cordless Shades:** ..... Add \$233 to the Standard Cordless Surcharge.

### ARCHES & QUARTER CIRCLES

WIDTH TO: >	24"	30"	36"	42"	48"	54"	60"	66"	72"	PRICE GROUP
<b>Stationary Arch</b>	410	467	519	587	671	756	855	955		<b>F2</b>
<b>Moveable Arch</b>	607	683	766	862	967	1095	1216	1346		
<b>Stationary Quarter Circle</b>	530	608	695	789	950					
<b>Moveable Quarter Circle</b>	742	851	972	1105	1329					

A template is required for all Non-perfect Stationary Arches.\* Moveable Arches are only available as Perfect Arches, (height equals 1/2 of the width). For all Quarter Circles, the width must equal the height.

\*For any shade requiring a template, there will be a template surcharge of \$151 added to the price of the shade.

**3/4" SINGLE CELL BLACKOUT**

SPECIFICATIONS • MINIMUMS / MAXIMUMS

**STANDARD RECTANGULAR:**

SINGLE SHADE

**Minimum Size:** 12" w x 8" h**Maximum Size:** 144" w x 120" h**TWO-ON-ONE HEADRAIL:****Minimum Size:** 16" w x 8" h**Maximum Size:** 144" w x 120" h**TWO-ON-ONE HEADRAIL WITH  
STANDARD CONTINUOUS CORD:****Minimum Size:** 44" w x 8" h**Maximum Size:** 144" w x 120" h**TOP-DOWN / BOTTOM-UP:****Minimum Size:** 12" w x 12" h**Maximum Size:** 72" w x 80" h**TOP-DOWN ONLY:****Minimum Size:** 12" w x 12" h**Maximum Size:** 72" w x 80" h**DELUXE CORDLESS AND TOP-  
DOWN/BOTTOM-UP LIFT  
SYSTEM:**

SINGLE SHADE

**Minimum Size:** 18" w x 8" h**Maximum Size:** 120" w x 84" h**STANDARD  
CONTINUOUS CORD:**

SINGLE SHADE

**Minimum Size:** 22" w x 8" h**Maximum Size:** 144" w x 120" h**DAY-NIGHT SHADES:\*****Minimum Size:** 12" w x 18" h**Maximum Size:** 72" w x 96" h\* 3/4" Single Cell Blackout fabric  
can only be combined with the  
following fabrics:

- 1/2" Double Cell Translucent
- 3/4" Single Cell Translucent
- 3/4" Single Cell Blackout

**STATIONARY ARCH:****Minimum Size:** 18" w x 9" h**Maximum Size:** 72" w x 36" h**MOVEABLE ARCH:\***

PERFECT ARCH ONLY

**Minimum Size:** 18" w x 9" h**Maximum Size:** 72" w x 36" h

\* Height must equal 1/2 width

**STATIONARY QUARTER CIRCLE:\*****Minimum Size:** 9" w x 9" h**Maximum Size:** 48" w x 48" h

\* Height must equal width

**MOVEABLE QUARTER CIRCLE:\*****Minimum Size:** 9" w x 9" h**Maximum Size:** 48" w x 48" h

\* Height must equal width

**ASCENT W/ RF TECHNOLOGY  
MOTORIZED SHADES:****Minimum Size:** 19 1/2" w x 8" h**Maximum Size:** \*For Standard Shade refer  
to the maximum height charts on page 7.**LONGITUDE VERTICAL SHADES:****Minimum Size:** 12" w x 24" h**Maximum Size:** 168" w x 120" h \*Please see  
page 29 for Longitude pricing and additional informa-  
tion.**STACKING HEIGHTS**

- Drop refers to shade fully extended.
- Stack refers to shade fully raised.
- Measurements do not include headrail and bottom rail.

**STANDARD RECTANGULAR:**

STACKING HEIGHTS

**Drop:** 48" 72" 84" 144"**Stack:** 1/2" 3/4" 1 1/8" 1 3/4"

# 3/4" SINGLE CELL BLACKOUT & SEMI SHEER TRANSLUCENT

STANDARD RECTANGULAR

PRICE GROUP  
**G1**

WIDTH TO:		24"	30"	36"	42"	48"	54"	60"	66"	72"	84"	96"	108"	120"	132"	144"
HEIGHT TO:	36"	483	546	603	678	740	811	874	955	1019	1154	1311	1450	1585	1715	1840
	42"	522	586	661	744	818	909	977	1065	1137	1301	1475	1631	1783	1940	2084
	48"	559	617	716	801	885	972	1065	1154	1240	1406	1612	1778	1952	2114	2283
	54"	591	661	759	855	958	1048	1146	1242	1335	1523	1742	1926	2121	2298	2479
	60"	624	698	813	916	1017	1119	1230	1332	1435	1636	1877	2072	2283	2477	2680
	66"	649	742	853	973	1080	1198	1303	1425	1526	1747	2001	2227	2444	2658	2866
	72"	674	776	892	1017	1132	1252	1367	1490	1599	1842	2104	2340	2570	2805	3025
	78"	706	811	936	1073	1198	1323	1445	1583	1698	1950	2231	2489	2736	2981	3219
	84"	735	853	989	1119	1261	1391	1524	1663	1798	2060	2366	2626	2896	3157	3415
	90"	765	882	1034	1174	1320	1460	1604	1747	1886	2165	2493	2771	3057	3332	3610
	96"	796	921	1078	1227	1386	1526	1678	1833	1986	2275	2623	2912	3223	3510	3800
	108"	852	1002	1171	1342	1504	1676	1839	2011	2168	2506	2879	3207	3539	3871	
120"	901	1065	1242	1431	1646	1786	1959	2151	2325	2680	3079	3446	3799	4233		

Continuous Cord System recommended for sizes within boxed area.

### STANDARD CONTINUOUS CORD SYSTEM SURCHARGES

WIDTH TO: >	24"	30"	36"	42"	48"	54"	60"	66"	72"	84"	96"	108"	120"	132"	144"
ADD:	135	144	159	167	173	177	180	198	202	215	232	244	256	271	283

### DELUXE CORDLESS LIFT SYSTEM SURCHARGES

WIDTH TO: >	24"	30"	36"	42"	48"	54"	60"	66"	72"	84"	96"	108"	120"
ADD:	150	159	176	185	191	195	198	218	224	238	255	266	281

### ASCENT W/ RF TECHNOLOGY MOTORIZED SYSTEM SURCHARGES

WIDTH TO: >	24"	30"	36"	42"	48"	54"	60"	66"	72"	84"	96"	108"	120"	120"	120"
ADD:	701	719	739	760	792	827	865	895	930	959	974	1027	1041	1056	1074

- For option specifications and surcharges refer to page 31
- Remote Control: \$200 (Purchase at least one hand-held remote control per order.)

### OTHER SURCHARGES

- Two-On-One Headrail:** ..... Price as **two** individual shades, add together, and add... \$151.
- Two-On-One Headrail with Standard Continuous Cord:** ..... Price as **two** individual shades, add together, add the Continuous Cord surcharges for **each** shade, and add... \$151.
- Top-Down/Bottom-Up:** ..... Price as a standard shade, and add... \$204.
- Top-Down Only Shades:** ..... Price as a standard shade, and add... \$204.
- Day-Night Shades:** ..... Price **each** fabric as a separate shade and add the **two** shades together.
- Top-Down/Bottom-Up Cordless Shades:** ..... Add \$233 to the Standard Cordless Surcharge.

### ARCHES & QUARTER CIRCLES

WIDTH TO: >	24"	30"	36"	42"	48"	54"	60"	66"	72"	PRICE GROUP
<b>Stationary Arch</b>	446	512	589	689	802	922	1059	1213	1381	<b>G2</b>
<b>Moveable Arch</b>	660	764	872	1001	1147	1318	1494	1670	1896	
<b>Stationary Quarter Circle</b>	583	686	809	935	1102					
<b>Moveable Quarter Circle</b>	816	961	1133	1308	1543					

A template is required for all Non-perfect Stationary Arches.\* Moveable Arches are only available as Perfect Arches, (height equals 1/2 of the width). For all Quarter Circles, the width must equal the height.

\*For any shade requiring a template, there will be a template surcharge of \$151 added to the price of the shade.

**3/8" SINGLE CELL TRANSLUCENT**

SPECIFICATIONS • MINIMUMS / MAXIMUMS

**STANDARD RECTANGULAR:**

SINGLE SHADE

**Minimum Size:** 12" w x 8" h**Maximum Size:** 144" w x 120" h**TWO-ON-ONE HEADRAIL:****Minimum Size:** 16" w x 8" h**Maximum Size:** 144" w x 120" h**TWO-ON-ONE HEADRAIL  
WITH STANDARD  
CONTINUOUS CORD:****Minimum Size:** 44" w x 8" h**Maximum Size:** 144" w x 120" h**TOP-DOWN / BOTTOM-UP:****Minimum Size:** 12" w x 12" h**Maximum Size:** 72" w x 96" h**TOP-DOWN ONLY:****Minimum Size:** 12" w x 12" h**Maximum Size:** 72" w x 96" h**DELUXE CORDLESS AND TOP-  
DOWN/BOTTOM-UP LIFT  
SYSTEM:**

SINGLE SHADE

**Minimum Size:** 18" w x 8" h**Maximum Size:** 120" w x 84" h**STANDARD  
CONTINUOUS CORD:**

SINGLE SHADE

**Minimum Size:** 22" w x 8" h**Maximum Size:** 144" w x 120" h**DAY-NIGHT SHADES:\*****Minimum Size:** 12" w x 18" h**Maximum Size:** 72" w x 96" h

\* 3/8" Single Cell Translucent fabric  
can only be combined with the  
following fabrics:

- 3/8" Double Cell Translucent
- 3/8" Single Cell Translucent
- 1/2" Single Cell Translucent
- 3/8" Single Cell Room Blackout  
- Bottom Panel Only

**STATIONARY ARCH:****Minimum Size:** 18" w x 9" h**Maximum Size:** 72" w x 36" h**MOVEABLE ARCH:\***

PERFECT ARCH ONLY

**Minimum Size:** 18" w x 9" h**Maximum Size:** 72" w x 36" h

\* Height must equal 1/2 width

**STATIONARY QUARTER CIRCLE:\*****Minimum Size:** 9" w x 9" h**Maximum Size:** 48" w x 48" h

\* Height must equal width

**MOVEABLE QUARTER CIRCLE:\*****Minimum Size:** 9" w x 9" h**Maximum Size:** 48" w x 48" h

\* Height must equal width

**ASCENT W/ RF TECHNOLOGY  
MOTORIZED SHADES:****Minimum Size:** 19 1/2" w x 8" h**Maximum Size:** \*For Standard Shade refer  
to the maximum height charts on page 7.**STACKING HEIGHTS**

- Drop refers to shade fully extended.
- Stack refers to shade fully raised.
- Measurements do not include headrail and bottom rail.

**STANDARD RECTANGULAR:**

STACKING HEIGHTS

**Drop:** 48" 72" 84" 144"**Stack:** 1/2" 3/4" 1" 1 1/2"

# 3/8" SINGLE CELL TRANSLUCENT

## STANDARD RECTANGULAR

PRICE GROUP  
**H1**

WIDTH TO:		24"	30"	36"	42"	48"	54"	60"	66"	72"	84"	96"	108"	120"	132"	144"
HEIGHT TO:	36"	384	433	483	544	597	647	700	765	815	928	1048	1168	1272	1382	1480
	42"	406	466	520	588	646	718	774	843	896	1027	1158	1284	1406	1538	1644
	48"	436	493	569	639	705	767	843	914	983	1112	1272	1403	1546	1676	1815
	54"	466	524	607	678	759	826	909	983	1065	1208	1379	1523	1683	1825	1975
	60"	490	558	649	723	806	885	978	1060	1142	1303	1489	1644	1815	1972	2143
	66"	512	600	684	777	864	955	1036	1137	1220	1399	1588	1773	1948	2128	2298
	72"	541	627	722	818	914	1016	1105	1208	1301	1494	1700	1893	2082	2278	2457
	78"	566	661	757	872	968	1070	1168	1284	1377	1585	1803	2014	2222	2422	2621
	84"	581	695	799	902	1019	1119	1230	1343	1452	1663	1901	2114	2342	2555	2770
	90"	610	716	842	951	1070	1173	1299	1413	1529	1752	2011	2237	2476	2699	2935
	96"	640	747	872	989	1120	1229	1350	1477	1604	1837	2104	2342	2597	2834	3076
	108"	683	813	945	1078	1212	1347	1477	1619	1747	2021	2303	2575	2847	3119	3383
120"	735	872	1019	1169	1315	1460	1599	1763	1899	2192	2509	2809	3101	3398	3687	

Continuous Cord System recommended for sizes within boxed area.

### STANDARD CONTINUOUS CORD SYSTEM SURCHARGES

WIDTH TO: >	24"	30"	36"	42"	48"	54"	60"	66"	72"	84"	96"	108"	120"	132"	144"
ADD:	135	144	159	167	173	177	180	198	202	215	232	244	256	271	283

### DELUXE CORDLESS LIFT SYSTEM SURCHARGES

WIDTH TO: >	24"	30"	36"	42"	48"	54"	60"	66"	72"	84"	96"	108"	120"
ADD:	150	159	176	185	191	195	198	218	224	238	255	266	281

### ASCENT W/ RF TECHNOLOGY MOTORIZED SYSTEM SURCHARGES

WIDTH TO: >	24"	30"	36"	42"	48"	54"	60"	66"	72"	84"	96"	108"	120"	120"	120"
ADD:	701	719	739	760	792	827	865	895	930	959	974	1027	1041	1056	1074

- For option specifications and surcharges refer to page 31
- Remote Control: \$200 (Purchase at least one hand-held remote control per order.)

### OTHER SURCHARGES

- Two-On-One Headrail:** ..... Price as **two** individual shades, add together, and add... \$151.
- Two-On-One Headrail with Standard Continuous Cord:** ..... Price as **two** individual shades, add together, add the Continuous Cord surcharges for **each** shade, and add... \$151.
- Top-Down/Bottom-Up:** ..... Price as a standard shade, and add... \$204.
- Top-Down Only Shades:** ..... Price as a standard shade, and add... \$204.
- Day-Night Shades:** ..... Price **each** fabric as a separate shade and add the **two** shades together.
- Top-Down/Bottom-Up Cordless Shades:** ..... Add \$233 to the Standard Cordless Surcharge.

### ARCHES & QUARTER CIRCLES

WIDTH TO: >	24"	30"	36"	42"	48"	54"	60"	66"	72"	PRICE GROUP
<b>Stationary Arch</b>	410	467	519	587	671	756	855	955	1074	<b>H2</b>
<b>Moveable Arch</b>	607	683	766	862	967	1095	1216	1346	1467	
<b>Stationary Quarter Circle</b>	530	608	695	789	950					
<b>Moveable Quarter Circle</b>	742	851	972	1105	1329					

A template is required for all Non-perfect Stationary Arches.\* Moveable Arches are only available as Perfect Arches, (height equals 1/2 of the width). For all Quarter Circles, the width must equal the height.

\*For any shade requiring a template, there will be a template surcharge of \$151 added to the price of the shade.

# 1/2" SINGLE CELL TRANSLUCENT

SPECIFICATIONS • MINIMUMS / MAXIMUMS

## STANDARD RECTANGULAR:

SINGLE SHADE

**Minimum Size:** 12" w x 8" h

**Maximum Size:** 96" w x 120" h

## TWO-ON-ONE HEADRAIL:

**Minimum Size:** 16" w x 8" h

**Maximum Size:** 144" w x 120" h

## TWO-ON-ONE HEADRAIL WITH STANDARD CONTINUOUS CORD:

**Minimum Size:** 44" w x 8" h

**Maximum Size:** 144" w x 120" h

## TOP-DOWN / BOTTOM-UP:

**Minimum Size:** 12" w x 12" h

**Maximum Size:** 72" w x 96" h

## TOP-DOWN ONLY:

**Minimum Size:** 12" w x 12" h

**Maximum Size:** 72" w x 96" h

## ASCENT W/ RF TECHNOLOGY MOTORIZED SHADES:

NOT AVAILABLE WITH THIS FABRIC

## DELUXE CORDLESS AND TOP- DOWN/BOTTOM-UP LIFT SYSTEM:

SINGLE SHADE

**Minimum Size:** 18" w x 8" h

**Maximum Size:** 120" w x 84" h

## STANDARD CONTINUOUS CORD:

SINGLE SHADE

**Minimum Size:** 22" w x 8" h

**Maximum Size:** 96" w x 120" h

## DAY-NIGHT SHADES:\*

**Minimum Size:** 12" w x 18" h

**Maximum Size:** 72" w x 96" h

\* 1/2" Single Cell Translucent fabric can only be combined with the following fabrics:

- 3/8" Double Cell Translucent
- 3/8" Single Cell Translucent
- 1/2" Single Cell Translucent
- 3/8" Single Cell Blackout
- Bottom Panel Only

## STATIONARY ARCH:

**Minimum Size:** 18" w x 9" h

**Maximum Size:** 72" w x 36" h

## MOVEABLE ARCH:\*

PERFECT ARCH ONLY

**Minimum Size:** 18" w x 9" h

**Maximum Size:** 72" w x 36" h

\* Height must equal 1/2 width

## STATIONARY QUARTER CIRCLE:\*

**Minimum Size:** 9" w x 9" h

**Maximum Size:** 48" w x 48" h

\* Height must equal width

## MOVEABLE QUARTER CIRCLE:\*

**Minimum Size:** 9" w x 9" h

**Maximum Size:** 48" w x 48" h

\* Height must equal width

## STACKING HEIGHTS

- Drop refers to shade fully extended.
- Stack refers to shade fully raised.
- Measurements do not include headrail and bottom rail.

## STANDARD RECTANGULAR:

STACKING HEIGHTS

**Drop:** 48" 72" 84" 96"

**Stack:** 1 1/4" 1 3/4" 2" 2 1/4"

# 1/2" SINGLE CELL TRANSLUCENT

## STANDARD RECTANGULAR

PRICE GROUP  
**11**

WIDTH TO:		24"	30"	36"	42"	48"	54"	60"	66"	72"	84"	96"
HEIGHT TO:	36"	321	363	411	463	512	558	604	649	699	802	902
	42"	343	392	446	506	558	610	665	717	771	886	1000
	48"	367	424	484	545	604	664	721	782	844	968	1095
	54"	389	451	519	584	650	714	778	852	915	1050	1191
	60"	416	480	557	623	695	769	838	915	986	1134	1285
	66"	441	512	591	667	745	823	895	978	1056	1215	1382
	72"	464	538	623	707	791	873	958	1045	1127	1299	1478
	78"	484	569	657	743	840	923	1017	1107	1200	1381	1571
	84"	502	593	690	782	883	969	1067	1163	1258	1449	1653
	90"	526	622	724	823	926	1024	1123	1227	1333	1537	1745
	96"	545	647	753	859	968	1070	1177	1286	1392	1608	1833
	108"	593	702	822	936	1057	1172	1287	1409	1527	1764	2010
120"	633	757	888	1017	1151	1276	1403	1534	1661	1922	2188	

### STANDARD CONTINUOUS CORD SYSTEM SURCHARGES

WIDTH TO: >	24"	30"	36"	42"	48"	54"	60"	66"	72"	84"	96"
<b>ADD:</b>	135	144	159	167	173	177	180	198	202	215	232

### DELUXE CORDLESS LIFT SYSTEM SURCHARGES

WIDTH TO: >	24"	30"	36"	42"	48"	54"	60"	66"	72"	84"	96"
<b>ADD:</b>	150	159	176	185	191	195	198	218	224	238	255

### OTHER SURCHARGES

- Two-On-One Headrail:** ..... Price as **two** individual shades, add together, and add... \$151.
- Two-On-One Headrail with Standard Continuous Cord:** ..... Price as **two** individual shades, add together, add the Continuous Cord surcharges for **each** shade, and add... \$151.
- Top-Down/Bottom-Up:** ..... Price as a standard shade, and add... \$204.
- Top-Down Only Shades:** ..... Price as a standard shade, and add... \$204.
- Day-Night Shades:** ..... Price **each** fabric as a separate shade and add the **two** shades together.
- Top-Down/Bottom-Up Cordless Shades:** ..... Add \$233 to the Standard Cordless Surcharge.

# 1/2" SINGLE CELL TRANSLUCENT

## ARCHES & QUARTER CIRCLES

PRICE GROUP  
**12**

WIDTH TO: >	24"	30"	36"	42"	48"	54"	60"	66"	72"
<b>Stationary Arch</b>	370	423	483	550	660	755	855	967	1085
<b>Moveable Arch</b>	530	598	682	776	925	1038	1167	1307	1462
<b>Stationary Quarter Circle</b>	481	550	628	716	815				
<b>Moveable Quarter Circle</b>	660	750	851	961	1085				

- A template is required for all Non-perfect Stationary Arches.\*
- Moveable Arches are only available as Perfect Arches, (height equals 1/2 of the width).
- For all Quarter Circles, the width must equal the height.

\*For any shade requiring a template, there will be a template surcharge of \$157 added to the price of the shade.

# 3/8" SINGLE CELL BLACKOUT & 3/8" DOUBLE CELL BLACKOUT

SPECIFICATIONS • MINIMUMS / MAXIMUMS

## STANDARD RECTANGULAR:

SINGLE SHADE

**Minimum Size:** 12" w x 8" h

**Maximum Size:** 144" w x 120" h

## TWO-ON-ONE HEADRAIL:

**Minimum Size:** 16" w x 8" h

**Maximum Size:** 144" w x 120" h

## TWO-ON-ONE HEADRAIL WITH STANDARD CONTINUOUS CORD:

**Minimum Size:** 44" w x 8" h

**Maximum Size:** 144" w x 120" h

## TOP-DOWN / BOTTOM-UP:

**Minimum Size:** 12" w x 12" h

**Maximum Size:** 72" w x 80" h

## TOP-DOWN ONLY:

**Minimum Size:** 12" w x 12" h

**Maximum Size:** 72" w x 80" h

## DELUXE CORDLESS LIFT SYSTEM:

NOT AVAILABLE ON THESE FABRICS

## STANDARD CONTINUOUS CORD:

SINGLE SHADE

**Minimum Size:** 22" w x 8" h

**Maximum Size:** 96" w x 120" h

## DAY-NIGHT SHADES:\*

**Minimum Size:** 12" w x 18" h

**Maximum Size:** 72" w x 96" h

\* Only available as the bottom panel in this shade

\* 3/8" Single or Double Cell Blackout fabrics can only be combined with the following fabrics:

- 3/8" Single Cell Translucent
- 3/8" Double Cell Translucent
- 1/2" Single Cell Translucent

## STATIONARY ARCH:

**Minimum Size:** 18" w x 9" h

**Maximum Size:** 72" w x 36" h

## MOVEABLE ARCH:\*

PERFECT ARCH ONLY

**Minimum Size:** 18" w x 9" h

**Maximum Size:** 72" w x 36" h

\* Height must equal 1/2 width

## STATIONARY QUARTER CIRCLE:\*

**Minimum Size:** 9" w x 9" h

**Maximum Size:** 48" w x 48" h

\* Height must equal width

## MOVEABLE QUARTER CIRCLE:\*

**Minimum Size:** 9" w x 9" h

**Maximum Size:** 48" w x 48" h

\* Height must equal width

## ASCENT W/ RF TECHNOLOGY MOTORIZED SHADES:

**Minimum Size:** 19 1/2" w x 8" h

**Maximum Size:** \*For Standard Shade refer to the maximum height charts on page 7.

## STACKING HEIGHT

- Drop refers to shade fully extended.
- Stack refers to shade fully raised.
- Measurements do not include headrail and bottom rail.

## STANDARD RECTANGULAR:

STACKING HEIGHTS

**Drop:** 48" 72" 84" 144"

**Stack:** 7/8" 1 1/16" 1 5/16" 2 3/16"

# 3/8" SINGLE CELL BLACKOUT & 3/8" DOUBLE CELL BLACKOUT

STANDARD RECTANGULAR

PRICE GROUP  
**J1**

WIDTH TO:		24"	30"	36"	42"	48"	54"	60"	66"	72"	84"	96"	108"	120"	132"	144"
HEIGHT TO:	36"	483	546	603	678	740	811	874	955	1019	1154	1311	1450	1585	1715	1840
	42"	522	586	661	744	818	909	977	1065	1137	1301	1475	1631	1783	1940	2084
	48"	559	617	716	801	885	972	1065	1154	1240	1406	1612	1778	1952	2114	2283
	54"	591	661	759	855	958	1048	1146	1242	1335	1523	1742	1926	2121	2298	2479
	60"	624	698	813	916	1017	1119	1230	1332	1435	1636	1877	2072	2283	2477	2680
	66"	649	742	853	973	1080	1198	1303	1425	1526	1747	2001	2227	2444	2658	2866
	72"	674	776	892	1017	1132	1252	1367	1490	1599	1842	2104	2340	2570	2805	3025
	78"	706	811	936	1073	1198	1323	1445	1583	1698	1950	2231	2489	2736	2981	3219
	84"	735	853	989	1119	1261	1391	1524	1663	1798	2060	2366	2626	2896	3157	3415
	90"	765	882	1034	1174	1320	1460	1604	1747	1886	2165	2493	2771	3057	3332	3610
	96"	796	921	1078	1227	1386	1526	1678	1833	1986	2275	2623	2912	3223	3510	3800
	108"	852	1002	1171	1342	1504	1676	1839	2011	2168	2506	2879	3207	3539	3871	
120"	901	1065	1242	1431	1646	1786	1959	2151	2325	2680	3079	3446	3799	4233		

Continuous Cord System recommended for sizes within boxed area.

### STANDARD CONTINUOUS CORD SYSTEM SURCHARGES

WIDTH TO: >	24"	30"	36"	42"	48"	54"	60"	66"	72"	84"	96"	108"	120"	132"	144"
ADD:	135	144	159	167	173	177	180	198	202	215	232	244	256	271	283

### ASCENT W/ RF TECHNOLOGY MOTORIZED SYSTEM SURCHARGES

WIDTH TO: >	24"	30"	36"	42"	48"	54"	60"	66"	72"	84"	96"	108"	120"	120"	120"
ADD:	701	719	739	760	792	827	865	895	930	959	974	1027	1041	1056	1074

- 3/8" Double Cell Blackout not available on the Accent Motorized System
- For option specifications and surcharges refer to page 31
- Remote Control: \$200 (Purchase at least one hand-held remote control per order.)

### OTHER SURCHARGES

- Two-On-One Headrail:** ..... Price as **two** individual shades, add together, and add... \$151.
- Two-On-One Headrail with Standard Continuous Cord:** ..... Price as **two** individual shades, add together, add the Continuous Cord surcharges for **each** shade, and add... \$151.
- Top-Down/Bottom-Up:** ..... Price as a standard shade, and add... \$204.
- Top-Down Only Shades:** ..... Price as a standard shade, and add... \$204.
- Day-Night Shades:** ..... Price **each** fabric as a separate shade and add the **two** shades together.

### ARCHES & QUARTER CIRCLES

WIDTH TO: >	24"	30"	36"	42"	48"	54"	60"	66"	72"	PRICE GROUP
<b>Stationary Arch</b>	446	512	589	689	802	922	1059	1213	1381	<b>J2</b>
<b>Moveable Arch</b>	660	764	872	1001	1147	1318	1494	1670	1896	
<b>Stationary Quarter Circle</b>	583	686	809	935	1102					
<b>Moveable Quarter Circle</b>	816	961	1133	1308	1543					

A template is required for all Non-perfect Stationary Arches.\* Moveable Arches are only available as Perfect Arches, (height equals 1/2 of the width). For all Quarter Circles, the width must equal the height.

\*For any shade requiring a template, there will be a template surcharge of \$151 added to the price of the shade.

## THE BEST OF FORM... FUNCTION... BEAUTY... AND VERSATILITY.

Longitude Honeycomb Shades offer all these features, making them the ideal choice to adorn any size or shape window, or door.

- Longitude Honeycomb Shades fit rectangular windows, sliding doors, and door openings
- Longitude Honeycomb Shades open and close from side to side to accommodate sliding glass doors, room dividers and French doors perfectly.
- Longitude Honeycomb Shades are available in five stacking configurations:
  - Left Stack
  - Right Stack
  - Split Stack/Center Opening
  - Center Stack
  - Dual Panel - is a Center Opening shade with a different fabric on each side. Each panel can fully span the width of the window.

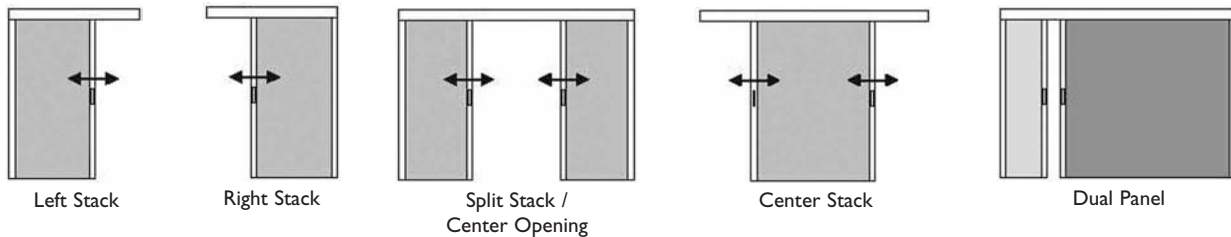

- Longitude Honeycomb Shades are available with 3/4" Single Cell Blackout and 3/4" Single Cell Translucent fabrics.

### SIZE SPECIFICATIONS

Minimum Width:	12"
Minimum Height:	24"
Maximum Width:	168"
Maximum Height:	120"

\*Note: For Center Opening or Dual Panel, specifications are per fabric panel.

\*Note: Center Opening Shades are available in widths up to 336". If width is greater than 168", it will be fabricated as two shades with a single valance piece to create the illusion of a single shade.

### MOUNTING REQUIREMENTS

Inside Mount:	Minimum mounting depth required is 3/4"
Flush Mount:	Minimum mounting depth required Aluminum Valance is 3 5/8" Minimum mounting depth required Alternative Wood Valance is 4"
Outside Mount:	Minimum flat vertical surface required is 5/8"
Fabric Stacking:	6 1/2" *note: fabric stack is determined by hardware and not ordered width

### FINISHED DIMENSIONS

Inside Mount:	· Headrail unit will measure ordered width less 3/16"
	· Shade height will measure ordered height less 1/2"
	· Valance width (non-flush) will measure ordered width plus 1 1/4"
	· Valance width (flush) will measure ordered width less 3/16"
Outside Mount:	· Headrail unit will measure ordered width
	· Shade height will measure ordered height
	· Valance width will measure ordered width plus 1 1/4"
	*width and height measurements may vary +/- 1/8"

# LONGITUDE 3/4" SINGLE CELL - TRANSLUCENT

SIDE STACK GRID

PRICE GROUP  
**K1**

WIDTH TO:		24"	30"	36"	42"	48"	54"	60"	66"	72"	78"	84"	96"	108"	120"	132"	144"	156"	168"
HEIGHT TO:	36"	832	902	983	1056	1122	1195	1271	1339	1415	1491	1556	1687	1815	1953	2079	2218	2343	2466
	42"	887	970	1059	1143	1216	1300	1386	1464	1548	1632	1705	1857	2003	2163	2304	2461	2602	2743
	48"	944	1033	1135	1226	1310	1402	1496	1595	1684	1768	1859	2032	2191	2367	2524	2701	2864	3018
	54"	996	1104	1208	1313	1404	1504	1606	1713	1815	1912	2011	2199	2380	2573	2756	2942	3117	3292
	60"	1054	1166	1284	1396	1496	1608	1721	1836	1943	2055	2160	2369	2565	2780	2976	3188	3381	3567
	66"	1114	1234	1360	1485	1595	1710	1828	1967	2076	2199	2301	2542	2754	2981	3196	3426	3635	3842
	72"	1177	1305	1438	1572	1697	1817	1940	2087	2210	2341	2456	2722	2942	3196	3423	3672	3894	4114
	78"	1237	1373	1517	1663	1794	1930	2061	2215	2346	2484	2605	2884	3125	3397	3645	3910	4150	4391
	84"	1300	1444	1593	1752	1896	2032	2176	2338	2484	2628	2756	3057	3313	3601	3862	4148	4412	4663
	90"	1355	1512	1676	1846	1990	2142	2296	2471	2620	2772	2916	3230	3499	3815	4098	4388	4660	4935
	96"	1412	1577	1755	1933	2084	2244	2416	2594	2756	2921	3068	3405	3690	4017	4323	4629	4919	5201
	102"	1472	1642	1828	2014	2173	2343	2524	2709	2882	3057	3206	3562	3865	4213	4532	4851	5157	5460
108"	1530	1710	1901	2095	2265	2440	2631	2824	3010	3188	3347	3721	4040	4399	4741	5073	5405	5717	
114"	1590	1781	1974	2178	2354	2539	2741	2942	3138	3326	3491	3883	4216	4592	4948	5298	5638	5973	
120"	1645	1841	2045	2257	2442	2636	2845	3057	3258	3455	3632	4040	4386	4780	5154	5523	5881	6229	

# LONGITUDE 3/4" SINGLE CELL - BLACKOUT

SIDE STACK GRID

PRICE GROUP  
**L1**

WIDTH TO:		24"	30"	36"	42"	48"	54"	60"	66"	72"	78"	84"	96"	108"	120"	132"	144"	156"	168"
HEIGHT TO:	36"	970	1067	1185	1289	1381	1472	1572	1674	1776	1875	1967	2142	2333	2508	2678	2840	3020	3188
	42"	1051	1166	1294	1415	1525	1629	1747	1854	1977	2079	2186	2382	2607	2801	3000	3185	3389	3580
	48"	1138	1263	1407	1535	1653	1781	1904	2040	2157	2286	2406	2626	2871	3096	3316	3528	3737	3944
	54"	1216	1362	1517	1661	1794	1927	2063	2215	2354	2497	2620	2871	3138	3389	3638	3876	4082	4302
	60"	1297	1454	1624	1786	1933	2082	2233	2390	2539	2707	2845	3115	3405	3679	3951	4210	4454	4673
	66"	1383	1553	1744	1919	2074	2239	2398	2573	2735	2913	3065	3366	3679	3970	4273	4555	4825	5047
	72"	1470	1645	1851	2048	2210	2388	2565	2754	2929	3122	3292	3609	3951	4260	4592	4893	5170	5405
	78"	1553	1739	1964	2176	2354	2544	2743	2937	3122	3337	3512	3855	4223	4545	4911	5235	5515	5764
	84"	1637	1833	2074	2293	2484	2683	2903	3117	3319	3543	3734	4100	4498	4846	5228	5573	5858	6119
	90"	1716	1927	2181	2427	2631	2843	3075	3300	3515	3753	3949	4346	4759	5131	5539	5910	6203	6478
	96"	1799	2016	2288	2547	2775	3000	3232	3481	3708	3964	4166	4592	5018	5421	5855	6253	6548	6852
	102"	1875	2110	2393	2667	2903	3143	3389	3653	3896	4163	4375	4827	5280	5704	6161	6580	6891	7223
108"	1953	2199	2495	2785	3036	3287	3551	3826	4082	4365	4587	5068	5539	5986	6465	6909	7249	7581	
114"	2032	2291	2599	2903	3169	3439	3708	3998	4270	4571	4799	5303	5800	6271	6776	7249	7594	7953	
120"	2108	2377	2704	3020	3300	3580	3862	4171	4456	4765	5011	5541	6062	6561	7082	7576	7934	8308	

## DESIGN OPTION SURCHARGES

Center Stack .....Add \$195 to shade base price.

Split Stack/Center Opening .....Divide full width measurement in half,  
price as two separate units and add the two prices together.

Dual Panel .....Price as two separate units and add together

## NO-CHARGE OPTIONS

- Extension brackets
- Spacer blocks

*Please note on order any options required.*

## HARDWARE INFORMATION

- The top and vertical rails are available in white only.
- Both the aluminum and alternative wood valances are coordinating white to the rail.

## VALANCE INFORMATION

An aluminum valance comes standard with your shade order. An alternative wood valance is also available at no extra charge. Please specify valance type on your order.

Aluminum valance height is 1 7/8"

Alternative Wood valance height is 3 1/4"

*\* Please note: Shade widths over 108" may require the valance to be spliced.*

## VALANCE RETURNS LENGTHS

Aluminum Valance 3 1/8"

Alternative Wood Valance 3 1/4"

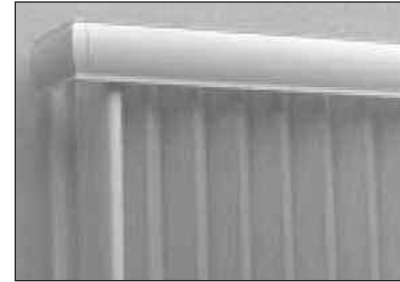

Aluminum Valance



Alternative Wood Valance

## CARING FOR SHADES

While beautiful and pleasing to the eye, all our products are designed to be durable, easily cared for and easily cleaned. Our non-woven fabrics are inherently anti-static and repel dust, but occasional feather dusting or vacuuming may be necessary to keep the fabrics clean and bright.

Spills and stains can be lightly blotted with a cloth or damp sponge. More difficult stains may require soaking in water with mild soap. For this, remove the shades from the window and submerge, soak and rub lightly. Please test any stronger cleaners on an unobtrusive portion of the shade.

*\* Please note: Do not immerse blackout fabric in water.*

## CHILD SAFETY

Longitude Honeycomb Shades feature no dangling cords, hanging chains, or wands, making them a safe choice for children and pets.

# MOUNTING REQUIREMENTS (FOR STANDARD AND TOP-DOWN ASCENT)

## 3/8" SINGLE CELL

**IB**

Minimum mounting depth: 1 1/2"  
 Minimum mounting depth, flush mount: 3"

**OB**

Minimum flat vertical surface: 3/4"

## 3/4" OR 1/2" DOUBLE CELL

**IB**

Minimum mounting depth: 1 1/2"  
 Minimum mounting depth, flush mount: 3 3/8"

**OB**

Minimum flat vertical surface: 1 1/4"

# ASCENT w/ RF TECHNOLOGY MOTORIZED LIFT SYSTEM OPTIONS

## APPLICATIONS

- Fits rectangular window opening.
- Standard shades.
- Selected fabrics.
- Battery powered remote control operation is standard (AC adapter is available at a surcharge).

Remote Control: **\$200**

*(Purchase at least one hand-held remote control per order.)*

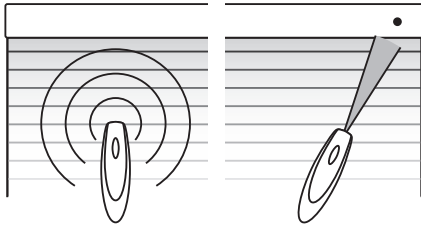

## OPTIONAL FEATURES

**• No Charge – Specify on Order**

1. Bracket shims.
2. Extension brackets.

**• Surcharge items – Specify on Order**

1. Remote control - \$200
2. Satellite battery mount - \$28
3. AC adapter - \$266
4. Cable Assembly 15" - \$25
5. Cable Assembly 4' - \$30
6. Cable Assembly 10' - \$44
7. Cable Assembly 20' - \$64

Note: Use one cable assembly for desired length with satellite battery mount or AC adapter.

## SATELLITE BATTERY PACK

The satellite battery pack will make changing batteries easier on tall or out-of-reach windows. Four cable lengths are available.

Satellite Battery Pack:	<b>\$55</b>
Cable Assembly 15":	<b>\$25</b>
Cable Assembly 4':	<b>\$30</b>
Cable Assembly 10':	<b>\$44</b>
Cable Assembly 20':	<b>\$64</b>

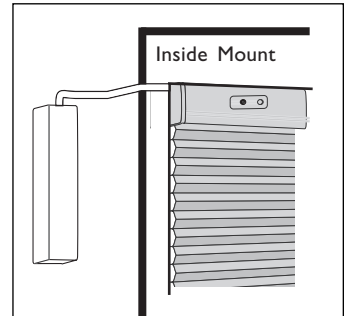
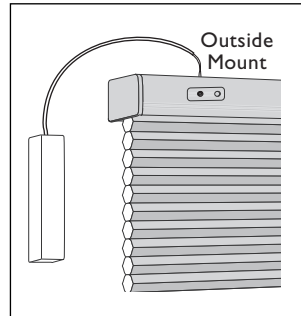

*Satellite Battery Pack*

## AC POWER ADAPTER

Eliminate the need for batteries by using the AC ADAPTER with any standard wall outlet. Four cable lengths are available.

Cable Assembly 15":	<b>\$25</b>
Cable Assembly 4':	<b>\$30</b>
Cable Assembly 10':	<b>\$44</b>
Cable Assembly 20':	<b>\$64</b>

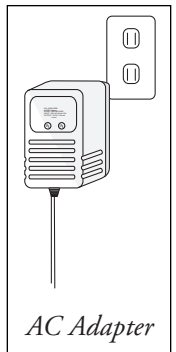

*AC Adapter*

## ASCENT w/ RF TECHNOLOGY MOTORIZED LIFT SYSTEM - ORDERING CONSIDERATIONS

### HOW TO PRICE

- Price using standard shade price grid then add motorized surcharge based on width.
- Add surcharge for at least 1 remote control.
- Add surcharge for any options listed in optional features.

### CHECKLIST FOR ORDERING ASCENT w/ RF TECHNOLOGY

- Order shade size and specify inside or outside mount.
- Price all applicable surcharges.
- Specify right or left sensor eye.
- Specify number of remotes.
- If ordering satellite battery pack, specify cable assembly length: 15", 4', 10' or 20'.
- If ordering AC adapter, specify cable assembly length: 15", 4', 10' or 20'.
- Order number of desired spacer shims.

### TWO METHODS OF OPERATION

#### RADIO CONTROL

- No aiming necessary (like a garage-door opener)
- Control window coverings individually or in groups
- Two-button operation

#### INFRARED CONTROL

- Line-of-sight operation (like a flashlight)
- Control window coverings individually
- Default mode of remote
- One-button operation

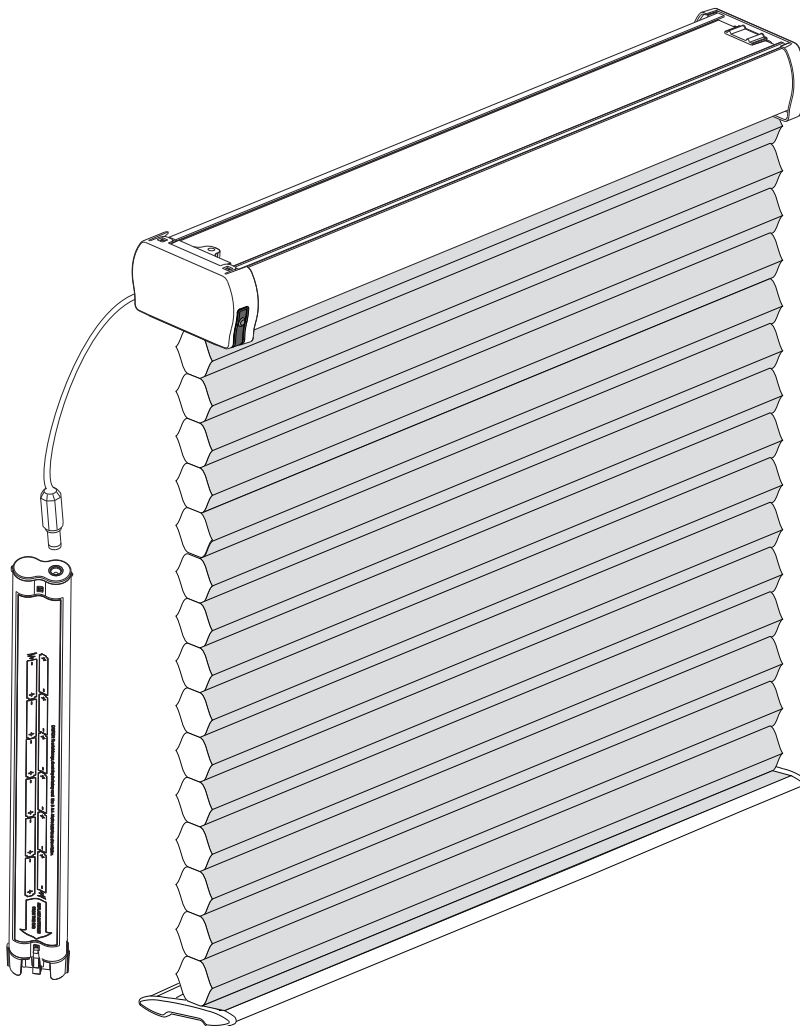

# MEASURING GUIDELINES

Accurate measurements are essential, for both correct pricing and proper fit. Use only a hard-edged ruler or steel tape, never a cloth tape. For inside mounts, width measurements **(A)** should be rounded down to the nearest 1/8" to prevent blind from binding against the window casing.

## INSIDE MOUNT OR CEILING MOUNT

Use a steel tape to measure the opening width **(A)** at three different places, and use the narrowest dimension when ordering. Be exact! The factory will make the shade 3/8" narrower so it will not rub against the window casing. Measure the height **(B)** of the window from the top (Soffit) down to the sill.

## OUTSIDE

Use a steel tape to measure the exact width **A** and height **B** of the area to be covered. It is recommended that the shades overlap the window by at least 1 1/2" on each side. When installation has no sill, allow the shade to overlap the bottom of the window casing by at least 1 1/2". Shade fabric will measure width and height indicated on the order.

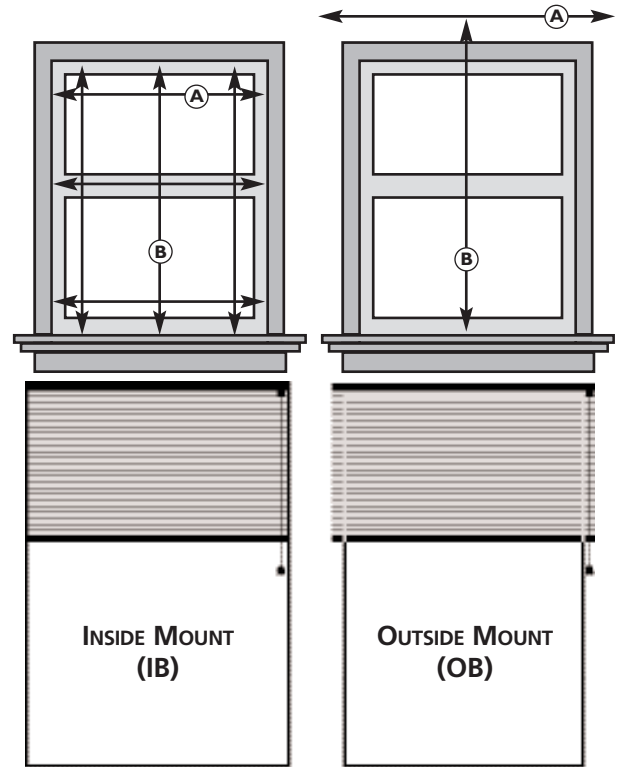

# MEASURING GUIDELINES

## ARCHES & QUARTER CIRCLES

1. For inside mounts, measure the exact width and height inside the window opening.
2. For outside mounts, measure the desired width and height.
3. Measure the height at its tallest point.

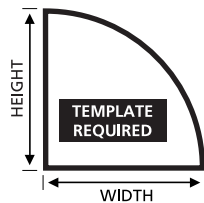
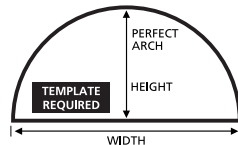

- All arch openings can only be for perfect arches where the height will equal one-half the width.
- For all quarter circles, the height must equal the width.

## CUT OUTS

- Cut-outs are available with all fabrics.
- Cut-outs are \$149 per side and are subject to approval by the fabricator.
- There are no limits on cut-out heights. There are, however, limits on cut-out widths:

Shade widths less than 18": 3" maximum width

Shade widths greater than 18": 5" maximum width

## FIVE STEPS TO AN ACCURATE TEMPLATE

1. Tape butcher paper or heavy wrapping paper over the window opening, allowing plenty of overlap. Do not use paper that has ever been folded; a template can have no folds or creases.
2. Draw an exact outline of the window opening. Do this by carefully tracing over the inside edge of the window frame.
3. Remove the paper from the window opening. If the blind is an outside mount, add the desired amount of overlap to the window outline and draw a second outline around it to match the shape of the finished blind.
4. Mark the blind dimensions on the template. Check that the template dimensions match the measurements of the actual window opening.
5. Identify the template and its orientation. Write the customer's name and PO# on the template, and mark the ROOM SIDE and TOP. Roll up the template and place it in a mailing tube.

**Do not fold the template.\***

**IMPORTANT:** Template must be cut out in the **exact shape** of the window opening and tested in window for correct fit.

\*For any shade requiring a template, there will be a template surcharge of \$151 added to the price of the shade.

## FABRIC INSULATION & LIGHT TRANSMISSION DATA

Honeycomb Shades offer a wide range of insulation and light values. Depending on the application requirements, one or more of these products is sure to provide the desired level of comfort and ambiance.

FABRIC TYPE	WINTER R-VALUE DOUBLE GLAZING	SUMMER R-VALUE DOUBLE GLAZING	SUMMER SHADING COEFFICIENT DOUBLE GLAZING	% UV BLOCKAGE	LIGHT TRANSMISSION	SOUND ABSORPTION
1/2" Double Cell – Translucent	4.35	2.90	0.35	98%	N/A	0.55
3/8" Soft Double Cell – Translucent*	3.30	N/A	0.25	99%	12%	N/A
3/8" Double Cell – Translucent	4.60	N/A	0.38	99%	11%	N/A
3/4" Single Cell – Blackout	5.00	4.35	0.36	99%	N/A	0.40
3/4" Single Cell – Translucent	3.60	2.90	0.44	98%	N/A	0.55
3/8" Single Cell – Translucent	3.70	2.80	0.45	99%	N/A	0.40
1/2" Single Cell – Translucent	3.20	N/A	0.45	98.7%	15%	N/A

\* Based on reported value of equivalent fabrics with duplicate cellular construction

### DEFINITION OF TERMS

**R-VALUES** measure resistance to heat flow. The higher the R-Value, the more insulation the product provides.

**SUMMER SHADING COEFFICIENT** measures the amount of heat passing through a covered window versus a bare window. The lower the number, the less heat is transferred. In summer, less heat transfer means a cooler room.

**% UV BLOCKAGE** measures the product's effectiveness at preventing harmful ultraviolet rays from entering the home's interior. The higher the percentage, the more UV rays are blocked.

**SOUND ABSORPTION** measures the amount of sound absorbed by the shade. The higher the number, the better the sound absorption.

## CHILD SAFETY

Our Honeycomb Shades are designed with child safety as a priority. To reduce the risk of strangulation, our fabrication methods incorporate features to comply with the current ANSI cord safety standard. Fabrication methods include breakaway cord stops, Cord-Shield cording, and tension devices.

To further reduce the risk of accidents, all cords should be kept out of the reach of children. Cord cleats can help implement this essential precaution and are therefore included with all standard cord lock/pull cord Honeycomb Shade products. The cord cleat should be mounted at a safe height, taking into account furniture or other objects upon which a child may climb.

After each use of the shade, excess cord should be wrapped around the cleat out of the reach of children.

For Honeycomb Shades made with a clutch operating system, our tension device is designed and is to be placed and shipped so that, unless it is properly installed (or altered from the shipped condition with sequential process or tools), it prevents the shade from operating. The tension device, once installed, can help prevent children from pulling cords around their necks.

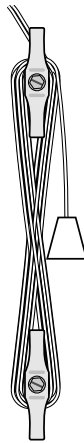

## CARE & CLEANING

While beautiful and delicate in appearance, Honeycomb Shades are designed to be durable, easily cared for and easily cleaned. The non-woven fabrics are inherently anti-static and repel dust. Occasional feather dusting or vacuuming may be necessary to keep the fabrics clean and bright.

Spills and stains can be lightly blotted with a cloth or damp sponge. More difficult stains may require soaking in water with mild soap. For this, remove the shades from the window and submerge, soak and rub lightly. **DO NOT** submerge the Deluxe Cordless headrail in water. Lay flat to dry or place back in window and raise tightly to recrisp pleats. Please test any stronger cleaners on an unobtrusive portion of the shade.

## MOUNTING

### Standard Rail:

- Minimum Shallow Mounting Surface: 1/2"
- Minimum Flush Inside Mounting Surface: 2"
- Minimum Outside Mounting Surface: 3/4"

### Deluxe Rail:

- Minimum Shallow Mounting Surface: 1/2"
- Minimum Flush Inside Mounting Surface: 2 1/2"
- Minimum Outside Mounting Surface: 3/4"

### Standard Continuous Cord System:

- Minimum Shallow Mounting Surface: 3/4"
- Minimum Flush Inside Mounting Surface: 1 3/4"
- Minimum Outside Mounting Surface: 1/2"

### Heavy Duty Continuous Cord System:

- Minimum Shallow Mounting Surface: 1"
- Minimum Flush Inside Mounting Surface: 2"
- Minimum Outside Mounting Surface: 1"

### Deluxe Cordless Lift System:

- Minimum Shallow Mounting Surface: 3/4"
- Minimum Flush Inside Mounting Surface: 2"
- Minimum Outside Mounting Surface: 1/2"

### Ascent Motorized Lift System:

- See page 27.

## RAIL MEASUREMENTS

When measuring and installing, please keep in mind the following rail measurements.

### Standard Rail:

- Depth: 1 7/16"
- Height: 1/2"

### Deluxe Rail:

- Depth: 1 7/8"
- Height: 1/2"

### Standard Continuous Cord System Rail:

- Depth: 1 11/16"
- Height: 1 5/16"

### Heavy Duty Continuous Cord System Rail:

- Depth: 2"
- Height: 2"

### Deluxe Cordless System Rail:

- Depth: 1 11/16"
- Height: 1 5/16"

### Ascent Motorized Lift System 3/8" Rail:

- Depth: 2"
- Height: 1 5/8"

### Ascent Motorized Lift System 3/4" Rail:

- Depth: 2 1/2"
- Height: 1 5/8"

## WIDTH LIMIT FOR SIDE MOUNT BRACKETS

There is a recommended 48" width limit on shades installed with side mount brackets.

## FINISHED SHADE DIMENSIONS

### INSIDE MOUNT:

- Headrail\* will measure ordered width less: ..... 3/16"
- Fabric will measure ordered width less: ..... 3/8"

### OUTSIDE MOUNT:

- Headrail\* will measure ordered width plus: ..... 3/16"
- Fabric will measure ordered width.

### EXACT (END CAP TO END CAP):

- Headrail\* will measure ordered width.
- Fabric will measure ordered width less ..... 3/16"

\*Headrail Measurements include end caps.  
Width and Width Measurements may vary +/- 1/8".

## LIMITED LIFETIME WARRANTY

Honeycomb Shades will be free from defects in materials and workmanship for as long as the original purchaser owns the product, provided that the product was installed properly and in accordance with the cellular shade installation instructions. This lifetime limited warranty is extended to the original purchaser only, in the original window for which it was intended.

This warranty does not include any conditions or damages resulting from accidents, alterations, misuse, abuse or failure to follow printed instructions on installation, care and cleaning or repairs. This warranty also does not apply to conditions resulting from normal wear and tear.

THIS WARRANTY IS EXCLUSIVE AND IN LIEU OF ALL OTHER OBLIGATIONS, LIABILITIES OR WARRANTIES. In no event shall the manufacturer of these Honeycomb Shades or its licensed fabricators or distributors be liable for INCIDENTAL OR CONSEQUENTIAL DAMAGES, or for any other damage, loss or expense, cost of fee associated with such damage. Some states do not allow the exclusion or limitation of incidental or consequential damages, so the above limitation may not apply.



Ascent shade motors and components are limited to a 5 year warranty.

