

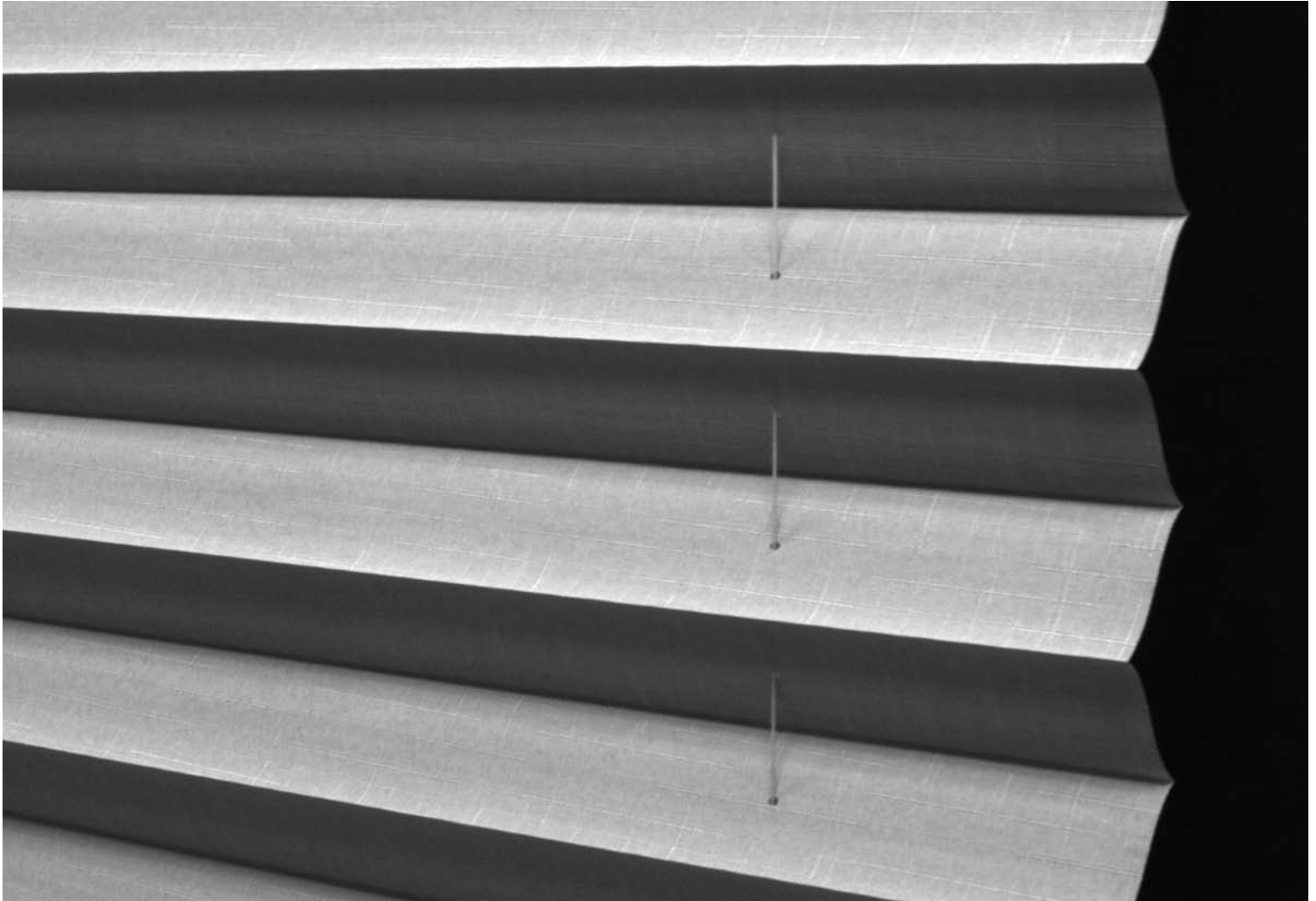

KENSINGTON
WINDOW EXPRESSIONS™



Product Reference & Price Guide

Pleated Shades

May 2010



TABLE OF CONTENTS

Collections..... 4

Fabric Specifications..... 5

Features and Options 6

How to Order 7

Pleated Price Grids 8-9

Liner Surcharges 10

Stationary Fan Style Arches 11

Specifications and Finished Dimensions12

Measuring and Mounting Information 13

Child Safety 14

Care and Cleaning..... 14

Warranty Information 14

Pleated Shades Order Form 15



Kensington Pleated Shades Program Summary

Kensington Pleated Shades bring elegant styling, flawless function and design versatility to windows. Backed by a limited lifetime warranty, these beautiful shades offer many advantages, making them the perfect choice for a wide range of applications.

PLEATED SHADES

- 14 fashionable fabrics in a multitude of colors to complement individual style and preferences.
- Wide variety of light control options to meet any degree of light filtration and desired privacy.
- Privacy and blackout liners available for added light control.
- Premium color-coordinated hardware for a refined aesthetic appearance.
- High performance hardware systems for smooth, precise operation.
- Several design options including: top-down/bottom-up, stationary arch and two-on-one headrail shades.
- Quality construction for years of dependable service.



COLLECTIONS

		Standard Rectangular	Standard Continuous Cord	2-on-1 Headrail	2-on-1 with Standard Continuous Cord	Top-Down / Bottom-Up	Liners Available
Minimum Size: All Fabrics	Width:	12"	22"	24"	44"	12"	
	Height:	12"	12"	12"	12"	12"	
Maximum Size: (Fabric Specific)							
Snowdonia (84")	Width:	96"	144"	144"	144"	72"	NO
	Height:	96"	96"	96"	96"	96"	
Cornwall (69")	Width:	96"	144"	144"	144"	69"	YES
	Height:	96"	96"	96"	96"	96"	
Country Linen (68")	Width:	96"	144"	144"	144"	68"	NO
	Height:	96"	96"	96"	96"	96"	
Regent (66")	Width:	96"	144"	144"	144"	66"	YES
	Height:	96"	96"	96"	96"	96"	
Avondale (68")	Width:	96"	144"	144"	144"	68"	NO
	Height:	96"	96"	96"	96"	96"	
Briarwood (68")	Width:	96"	144"	144"	144"	68"	NO
	Height:	96"	96"	96"	96"	96"	
English Harvest (68")	Width:	96"	144"	144"	144"	68"	NO
	Height:	96"	96"	96"	96"	96"	
Notting Hill (66")	Width:	96"	144"	144"	144"	66"	YES
	Height:	96"	96"	96"	96"	96"	
Swansea (60")	Width:	96"	144"	144"	144"	60"	YES
	Height:	96"	96"	96"	96"	96"	
Brushed Suede (62")	Width:	96"	144"	144"	144"	62"	NO
	Height:	96"	96"	96"	96"	96"	
Impressions (66")	Width:	96"	144"	144"	144"	66"	NO
	Height:	96"	96"	96"	96"	96"	
Herne Bay (56")	Width:	96"	144"	144"	144"	56"	YES
	Height:	96"	96"	96"	96"	96"	
Privacy Liner (72")	Width:	96"	144"	144"	144"	68"	N/A
	Height:	96"	96"	96"	96"	96"	
Blackout Liner (72")	Width:	96"	144"	144"	144"	68"	N/A
	Height:	96"	96"	96"	96"	96"	

* A shade will have a visible seam when the ordered width is greater than the fabric's single panel maximum width. The single panel maximum width is noted in parenthesis next to the fabric name.

FABRIC/PRODUCT SPECIFICATIONS

FABRIC INFORMATION

- Maximum width of a single panel varies by fabric type. See price grids for maximum single panel width. Wider shades will have two visible seams.
- It is common with high quality woven textile fabrics for minor waviness to occur. These variations are considered inherent characteristics of this product and in no way detract from the beauty of the fabric.
- For Privacy and Blackout liners, use liner price grids on page 10 and add to price of shade. Liners are not available with Snowdonia.

Standard Rectangular Stack Height:				
Drop	48"	72"	84"	96"
Stack*	2 ¹ / ₄ "	2 ³ / ₄ "	3"	3 ¹ / ₄ "

*Measurements include head and bottom rails and vary with fabric type.

FINISHED DIMENSIONS

Inside Mount:

- Fabric will measure ordered width less: ³/₈"
- Headrail* will measure ordered width less: ³/₁₆"

Outside Mount:

- Fabric will measure ordered width.
- Headrail* will measure ordered width plus: ³/₁₆"

Exact (End Cap to End Cap):

- Fabric will measure ordered width less: ³/₁₆"
- Headrail* will measure ordered width.

*Headrail Measurements include end caps.
Width and Length Measurements may vary +/- ¹/₈".

NO CHARGE OPTIONS:

- | | |
|------------------------|----------------------|
| • Special Cord Lengths | • Extension Brackets |
| • Hold Down Brackets | • Cord Cleats |
| • Spacer Blocks | • Side Mount |

Note on order any options required.

MOUNTING

Standard Rail:

Minimum Shallow Mounting Surface:	1/2"
Minimum Flush Inside Mounting Surface:	2"
Minimum Outside Mounting Surface:	3/4"

Standard Continuous Cord System:

Minimum Shallow Mounting Surface:	3/4"
Minimum Flush Inside Mounting Surface:	1 ³ / ₄ "
Minimum Outside Mounting Surface:	1 ¹ / ₂ "

RAIL MEASUREMENTS

When measuring and installing, please keep in mind the following rail measurements.

Standard Rail:

Depth:	1 ⁷ / ₁₆ "
Height:	1 ¹ / ₂ "

Standard Continuous Cord System:

Depth:	1 ¹¹ / ₁₆ "
Height:	1 ⁵ / ₁₆ "

WIDTH FOR SIDE MOUNT BRACKETS

There is a recommended 48" width limit on shades installed with side mount brackets.

FEATURES AND OPTIONS

**STANDARD
RECTANGULAR**

The traditional cord operated pleated shade that raises from the bottom up and stacks at the top.

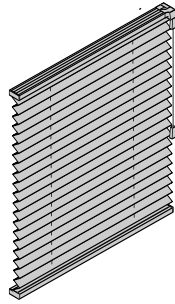
**DAY-NIGHT**

The Day-Night Shade allows you to choose two different fabrics to use on one shade. One fabric is used on the top and one on the bottom and a moving rail connects them. This shade provides a variety of light control and privacy options.

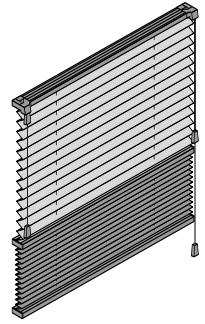
**CONTINUOUS
CORD SYSTEM**

The continuous cord design ensures your shade will open smoothly and evenly. The cord is shorter than the traditional cord and makes for a neater appearance. The special clutch system will keep the shade at the exact height desired. This feature is the ideal option for larger shades, eliminating long dangling cords.

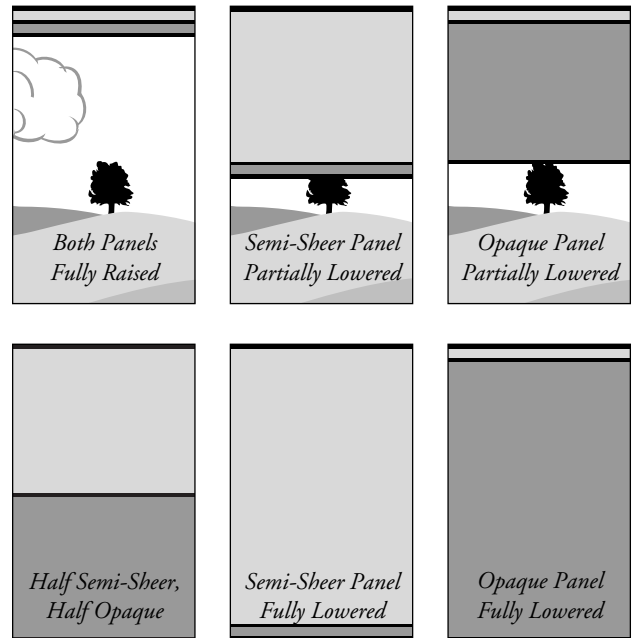
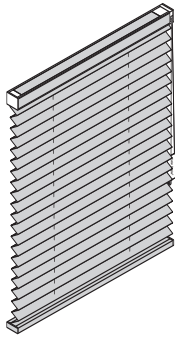
**TOP-DOWN/
BOTTOM-UP**

This option can be opened from both the top and the bottom. Right and left hand controls allow the shade to be lowered and raised. This style is ideal for letting natural light in through the top while preserving privacy below. It also floods the room with light by opening it completely from the bottom up.

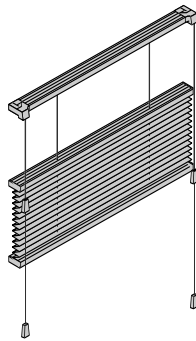
**TWO-ON-ONE HEADRAIL**

For very large single windows or two large windows side by side, this specialty shade provides you with the appearance of a single shade, with two shades operating independently. Also available with a splicer or a Continuous Cord System.

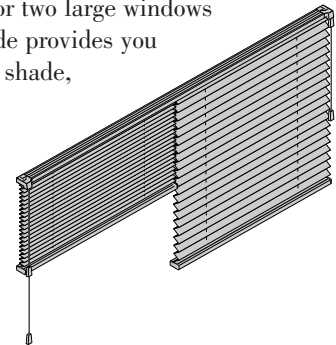
**STATIONARY ARCH**

The classic starburst design can be ordered to fit almost any Perfect Arch dimensions.

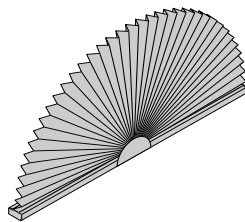

HOW TO ORDER

The total retail price for a Pleated Shade is determined by the following information:

- Fabric selection
- The size of the shade ordered
- Options requested

FABRIC SELECTION - Each fabric uses a separate price chart located in the pricing section, pages 8 and 9.

- **Size Limitations:** Some options are only available in restricted sizes.

SIZE OF SHADE - On the appropriate price chart, the shade's base price is determined by the size of the shade.

- Round **UP** the shade's measured width and height to the nearest width and height dimensions on the chart.
- Locate the shade's base price - follow down the column under the shade's rounded-up width until it crosses the line of prices for the shade's rounded-up height. Where the two intersect is the shade's correct base price.

REQUESTED OPTIONS - Below each price chart is information for that fabric's available options. Add the appropriate **surcharges** to the shade's base price to arrive at the shade's total price.

ORDERING TIPS - Use the order form on page 15 when ordering Pleated Shades:

- **Size Limitations:** Some options are only available in restricted sizes. See pages 4 for details by fabric.
- **Day-Night Shade Fabric Restrictions:** Fabric combinations are limited to two fabric groups. Refer to the appropriate specifications page for details.
- **Continuous Cord Recommendations:** Large shades, within the boxed area of the price charts, are easier to operate using a continuous cord system.
- Be sure to use exact width and height dimensions when ordering.

IMPORTANT ORDERING INFORMATION

In addition to the correct price, all orders must include the following information:

- Fabric selection
- Color name and color number
- All options requested
- Position of controls, left or right side
- Accurate measurements for the shade's width and height
- Type of mounting required:
 - Inside Mount (IB)
 - Outside Mount (OB)
 - End Mount (EM)
- Desired window/wall clearance
- Other options such as hold-down brackets

PRICING EXAMPLE - Determine the final price for the following shade (Fig. 1):

- Pleated Shade
- Fabric: Avondale
- Size: 62" x 80"
- Options: Standard Continuous Cord System

1. Locate the appropriate price chart, **Price Group 2A** on page 8.
2. Round **UP** the shade's measurements to the nearest width and height on the chart, **66" x 84"**.
3. Find the correct **base price**, where the rounded-up width price column crosses the rounded-up height price line. **\$311.00**
4. Add the **surcharge** for Standard Continuous Cord System from the corresponding rounded-up width price column **+63.00**
5. Add the two together for final price **\$374.00**

PRICING EXAMPLE

8 KENSINGTON PLEATED SHADES

PRICE GROUP 1A STANDARD RECTANGULAR

- Snowdonia (84")
- Cornwall (69") • Privacy Liner Only (72")

Width:	24"	30"	36"	42"	48"	54"	60"	66"	72"	84"	96"	108"	120"	132"	144"
36"	67	71	79	87	94	101	109	119	128	148	163	177	193	207	222
42"	69	77	86	95	103	110	119	130	141	161	179	191	213	229	244
48"	72	83	96	103	111	118	128	140	153	176	195	210	234	250	266
54"	75	88	103	112	119	128	137	151	164	190	211	225	253	271	289
60"	83	95	109	119	127	137	148	162	176	203	225	244	270	293	317
66"	93	102	115	123	134	146	159	173	188	219	243	266	293	319	347
72"	101	109	119	128	146	157	171	186	201	232	261	288	317	343	370
78"	107	113	123	134	153	167	182	198	214	247	279	305	340	366	392
84"	113	120	127	141	162	177	191	211	230	264	298	322	359	388	416
90"	117	126	134	147	171	186	201	222	244	280	316	342	381	410	438
96"	121	130	138	155	179	193	212	234	263	298	333	358	400	432	464

Continuous Cord System or Two-on-One Headrail required for shades over 96" in width.

PRICE GROUP 2A STANDARD RECTANGULAR

- Regent (66")
- Country Linen (68")
- Avondale (68")
- Blackout Liner Only (72")

Width:	24"	30"	36"	42"	48"	54"	60"	66"	72"	84"	96"	108"	120"	132"	144"
36"	98	105	116	128	139	149	161	175	189	218	240	261	285	306	327
42"	102	114	127	140	152	162	175	192	208	238	264	282	314	338	360
48"	107	122	142	152	164	174	189	207	225	260	288	310	343	369	392
54"	111	130	152	165	175	188	202	222	242	280	311	332	373	400	427
60"	122	140	161	176	187	202	218	239	260	300	332	360	398	433	467
66"	137	151	169	182	198	216	234	255	277	323	358	392	432	471	511
72"	149	161	176	188	215	232	252	274	296	342	385	424	467	506	545
78"	158	167	182	198	225	246	268	292	315	365	411	450	501	540	578
84"	167	177	188	208	237	261	286	311	340	389	440	476	530	573	614
90"	173	186	198	217	252	274	297	328	360	414	467	504	562	604	646
96"	179	192	204	229	264	285	313	345	388	440	491	528	590	637	684

Continuous Cord System or Two-on-One Headrail required for shades over 96" in width.

STANDARD CONTINUOUS CORD SYSTEM SURCHARGES (add to Standard Rectangular price)

WIDTH TO >	24"	30"	36"	42"	48"	54"	60"	66"	72"	84"	96"	108"	120"	132"	144"
Add:	43	45	50	53	55	56	57	63	64	68	73	77	82	85	90

SPECIALTY SHADE SURCHARGES (add to Standard Rectangular price)

Two-on-One Headrail.....Price as two individual shades and add \$38.

Two-on-One Headrail with Standard Continuous Cord.....Price as two individual shades, add Standard Continuous Cord surcharges for each and add \$38.

Top-Down / Bottom-Up.....Add \$69.

Day-Night.....Price as two separate shades using overall dimensions and add together

Fig. 1

PRICE GROUP

1A**STANDARD
RECTANGULAR**

- Snowdonia (84")
- Cornwall (69")
- Privacy Liner Only (72")

Height To:	Width:	24"	30"	36"	42"	48"	54"	60"	66"	72"	84"	96"	108"	120"	132"	144"
	36"	67	71	79	87	94	101	109	119	128	148	163	177	193	207	222
42"	69	77	86	95	103	110	119	130	141	161	179	191	213	229	244	
48"	72	83	96	103	111	118	128	140	153	176	195	210	233	250	266	
54"	75	88	103	112	119	128	137	151	164	190	211	225	253	271	289	
60"	83	95	109	119	127	137	148	162	176	203	225	244	270	293	317	
66"	93	102	115	123	134	146	159	173	188	219	243	266	293	319	347	
72"	101	109	119	128	146	157	171	186	201	232	261	288	317	343	370	
78"	107	113	123	134	153	167	182	198	214	247	279	305	340	366	392	
84"	113	120	127	141	162	177	191	211	230	264	298	322	359	388	416	
90"	117	126	134	147	171	186	201	222	244	280	316	342	381	410	438	
96"	121	130	138	155	179	193	212	234	263	298	333	358	400	432	464	

Continuous Cord System or Two-on-One Headrail required for shades over 96" in width.

PRICE GROUP

2A**STANDARD
RECTANGULAR**

- Regent (66")
- Country Linen (68")
- Avondale (68")
- Blackout Liner Only (72")

Height To:	Width:	24"	30"	36"	42"	48"	54"	60"	66"	72"	84"	96"	108"	120"	132"	144"
	36"	98	105	116	128	139	149	161	175	189	218	240	261	285	306	327
42"	102	114	127	140	152	162	175	192	208	238	264	282	314	338	360	
48"	107	122	142	152	164	174	189	207	225	260	288	310	343	369	392	
54"	111	130	152	165	175	188	202	222	242	280	311	332	373	400	427	
60"	122	140	161	176	187	202	218	239	260	300	332	360	398	433	467	
66"	137	151	169	182	198	216	234	255	277	323	358	392	432	471	511	
72"	149	161	176	188	215	232	252	274	296	342	385	424	467	506	545	
78"	158	167	182	198	225	246	268	292	315	365	411	450	501	540	578	
84"	167	177	188	208	239	261	282	311	340	389	440	476	530	573	614	
90"	173	186	198	217	252	274	297	328	360	414	467	504	562	604	646	
96"	179	192	204	229	264	285	313	345	388	440	491	528	590	637	684	

Continuous Cord System or Two-on-One Headrail required for shades over 96" in width.

STANDARD CONTINUOUS CORD SYSTEM SURCHARGES (add to Standard Rectangular price)

WIDTH TO: >	24"	30"	36"	42"	48"	54"	60"	66"	72"	84"	96"	108"	120"	132"	144"
Add:	43	45	50	53	55	56	57	63	64	68	73	77	82	85	90

SPECIALTY SHADE SURCHARGES (add to Standard Rectangular price)

Two-on-One Headrail.....Price as two individual shades and add \$38.

Two-on-One Headrail with Standard Continuous CordPrice as two individual shades, add Standard Continuous Cord surcharges for each and add \$38.

Top-Down / Bottom-Up.....Add \$69.

Day-Night.....Price as two separate shades using overall dimensions and add together

PRICE GROUP		STANDARD											<ul style="list-style-type: none"> • Briarwood (68") • English Harvest (68") 			
3A		RECTANGULAR														
Height To:	Width:	24"	30"	36"	42"	48"	54"	60"	66"	72"	84"	96"	108"	120"	132"	144"
	36"	106	113	125	138	149	161	173	188	203	235	258	280	306	329	351
	42"	109	123	137	151	163	174	188	206	224	255	283	303	337	363	387
	48"	114	131	153	163	176	187	203	222	242	280	309	333	369	397	422
	54"	119	140	163	178	188	202	217	239	260	301	334	357	401	430	459
	60"	131	151	173	189	201	217	235	257	280	322	357	386	428	465	502
	66"	147	162	182	195	213	232	251	274	297	347	384	422	464	506	549
	72"	160	173	189	202	231	249	271	294	318	367	414	456	502	544	586
	78"	170	179	195	212	242	265	288	314	339	392	442	484	539	581	621
	84"	179	191	201	223	257	280	303	335	365	418	473	511	569	615	659
	90"	186	200	213	233	271	295	319	352	386	445	501	542	604	649	694
96"	193	207	219	246	284	306	336	371	416	473	528	567	635	684	735	

Continuous Cord System or Two-on-One Headrail required for shades over 96" in width.

PRICE GROUP		STANDARD											<ul style="list-style-type: none"> • Impressions (66") • Herne Bay (56") • Notting Hill (66") • Swansea (60") • Brushed Suede (62") 			
4A		RECTANGULAR														
Height To:	Width:	24"	30"	36"	42"	48"	54"	60"	66"	72"	84"	96"	108"	120"	132"	144"
	36"	118	126	139	154	166	179	193	210	227	262	289	313	342	367	392
	42"	122	137	153	169	182	194	210	230	250	285	316	338	376	406	432
	48"	128	146	171	182	196	209	226	248	270	312	345	372	412	443	471
	54"	133	156	182	199	210	226	243	266	290	336	373	399	448	480	512
	60"	146	169	194	211	224	242	262	287	312	360	399	431	478	519	561
	66"	164	181	203	218	238	259	281	306	332	387	429	471	518	565	614
	72"	179	193	211	226	258	278	303	329	355	410	462	509	561	607	654
	78"	190	200	218	237	270	296	322	351	379	438	494	540	601	649	694
	84"	200	213	225	249	287	313	339	374	408	466	528	571	636	687	736
	90"	208	223	238	261	303	329	356	394	431	496	560	605	674	725	775
96"	215	231	245	274	317	342	375	414	465	528	589	634	709	764	821	

Continuous Cord System or Two-on-One Headrail required for shades over 96" in width.

STANDARD CONTINUOUS CORD SYSTEM SURCHARGES (add to Standard Rectangular price)

WIDTH TO: >	24"	30"	36"	42"	48"	54"	60"	66"	72"	84"	96"	108"	120"	132"	144"
Add:	43	45	50	53	55	56	57	63	64	68	73	77	82	85	90

SPECIALTY SHADE SURCHARGES (add to Standard Rectangular price)

Two-on-One Headrail.....Price as two individual shades and add \$38

Two-on-One Headrail with Standard Continuous CordPrice as two individual shades, add Standard Continuous Cord surcharges for each and add \$38

Top-Down / Bottom-Up.....Add \$69

Day-Night.....Price as two separate shades using overall dimensions and add together

PRIVACY LINER SURCHARGES

Height To:	Width:	24"	30"	36"	42"	48"	54"	60"	66"	72"	84"	96"	108"	120"
	36"	17	21	24	26	29	32	34	36	39	45	50	54	61
42"	19	22	25	29	31	34	37	40	42	49	56	59	66	
48"	20	24	27	30	33	36	39	42	46	54	60	64	71	
54"	21	25	29	31	36	39	42	46	50	57	64	69	77	
60"	22	26	31	33	38	42	45	49	53	63	69	75	83	
66"	24	29	32	36	40	44	48	53	57	66	74	80	89	
72"	25	31	35	38	43	47	50	56	61	71	79	84	94	
78"	26	31	38	40	46	50	54	60	66	75	84	90	101	
84"	28	34	39	42	48	52	56	63	69	80	89	95	107	
90"	31	36	42	45	50	55	60	66	73	86	93	101	113	
96"	31	38	44	49	54	56	63	69	77	89	100	106	119	

NOTE: Liners are NOT available with Snowdonia.

BLACKOUT LINER SURCHARGES

Height To:	Width:	24"	30"	36"	42"	48"	54"	60"	66"	72"	84"	96"	108"	120"
	36"	32	38	42	47	52	57	61	66	71	80	90	98	108
42"	34	40	45	50	56	61	65	71	76	89	99	107	117	
48"	36	42	49	53	60	65	70	77	83	96	107	115	127	
54"	38	45	52	56	64	69	75	82	90	103	114	124	136	
60"	39	48	55	60	68	74	80	88	96	111	123	133	148	
66"	42	50	59	65	72	79	86	94	102	118	132	142	158	
72"	44	54	62	68	78	84	91	100	108	126	140	151	169	
78"	47	57	66	71	82	89	96	107	116	134	150	161	180	
84"	49	61	70	76	86	94	101	112	122	142	158	170	191	
90"	54	64	74	80	91	100	107	118	130	151	167	180	201	
96"	55	67	78	86	97	102	113	125	138	159	178	190	212	

NOTE: Liners are NOT available with Snowdonia.

HOW TO PRICE A LINER

Example:

Swansea Polar in 54" x 70"

1. Price fabric using standard rectangular price chart.
2. Price what type of liner, either Privacy or Blackout, and add together.

Use price grid A4 on page 9 for Swansea panel.

\$278

Use Blackout Liner price grid on this page.

+\$ 84

\$362

PRICE GROUP

B

**STATIONARY FAN
STYLE ARCHES**

Fabrics	Width:	24"	30"	36"	42"	48"	54"	60"	66"	72"
	Snowdonia, Cornwall		70	85	98	110	127	140	153	167
Country Linen - Regent - Avondale		90	110	128	142	164	181	198	217	239
Briarwood - English Harvest		103	125	145	163	188	207	226	247	273
Notting Hill, Swansea Brushed Suede, Impressions Herne Bay		111	135	156	174	201	222	243	266	294

STATIONARY FAN STYLE ARCHES

Width and Height Dimensions:

Minimum Width:..... 18"	Maximum Width:..... 72"
Minimum Height:..... 9"	Maximum Height:..... 36"

- Kensington Stationary Fan Style Arch shades are available as **perfect arches** only and do not require a template. The height must be exactly 1/2 the width.
- Make sure the radius of the arch remains constant to ensure a proper fit. (Fig. 2)
- It is common with high quality woven textile fabrics for minor waviness to occur. These variations are considered inherent characteristics of this product and in no way detract from the beauty of the fabric.
- Stationary fan style arches are not available with liners.

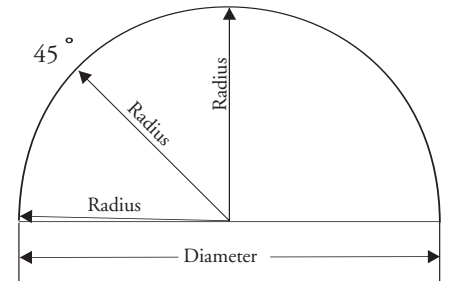

Fig. 2

SPECIFICATIONS AND FINISHED DIMENSIONS

DAY-NIGHT SHADES

See below for size specifications.

- Day-Night Shades are made with two operating cord locks, one on the left and right side of the shade.
- Day-Night Shades maximum width is limited to the maximum size of a single panel, which varies with fabric.
- Day-Night Shades use two fabric panels - one between the headrail and center rail, and one between the center rail and bottom rail. Either panel, or portion of a panel can be used to cover the window.
- Pleated fabric cannot be paneled in Day-Night applications. When using pleated fabrics, the maximum width of the whole shade (both panels) is limited to the fabric size. See pricing example at right.
- Pleated liners cannot be placed on the top fabric panel.
- On Day-Night Shades, top rail and center rail will coordinate with top fabric and bottom rail will coordinate with the bottom fabric.
- The cord and tassel will be coordinated with the bottom panel fabric.

DAY-NIGHT SHADE SURCHARGE:

Price each fabric panel as a separate shade using standard rectangular price grids, then add the two prices together.

PRICING EXAMPLE:

50" x 70" Regent fabric and 50" x 70" Notting Hill fabric

1. Price each fabric panel as a separate shade using standard rectangular price charts and add two prices together	
Use Price Group 2A for Regent fabric panel (54" x 72").....	\$232
Use Price Group 4A for Notting Hill fabric panel (54" x 72").....	+ 270
	\$510

DAY - NIGHT SHADE SIZE LIMITATIONS

FABRIC	TOP FABRIC				BOTTOM FABRIC				PRICE GROUP
	WIDTH		LENGTH		WIDTH		LENGTH		
	MIN	MAX	MIN	MAX	MIN	MAX	MIN	MAX	
Snowdonia	12"	72"	18"	96"	12"	72"	18"	96"	A1
Cornwall	12"	69"	18"	96"	12"	69"	18"	96"	A1
Country Linen	12"	68"	18"	96"	12"	68"	18"	96"	A2
Regent	12"	66"	18"	96"	12"	66"	18"	96"	A2
Avondale	12"	68"	18"	96"	12"	68"	18"	96"	A2
Briarwood	12"	68"	18"	96"	12"	68"	18"	96"	A3
English Harvest	12"	68"	18"	96"	12"	68"	18"	96"	A3
Notting Hill	12"	66"	18"	96"	12"	66"	18"	96"	A4
Swansea	12"	60"	18"	96"	12"	60"	18"	96"	A4
Brushed Suede	12"	62"	18"	96"	12"	62"	18"	96"	A4
Impressions	12"	66"	18"	96"	12"	66"	18"	96"	A4
Herne Bay	12"	56"	18"	96"	12"	56"	18"	96"	A4

MEASURING GUIDELINES

Accurate measurements are essential, for both correct pricing and proper fit. Use only a hard-edged ruler or steel tape, never a cloth tape. For inside mounts, width measurements (A) should be rounded **down** to the nearest 1/8" to prevent blind from binding against the window casing.

INSIDE MOUNT

Use a steel tape to measure the opening width (A) at three different places, and use the narrowest dimension when ordering. Be exact! The factory will make the shade 3/8" narrower so it will not rub against the window casing. Measure the height (B) of the window from the top (soffit) down to the sill.

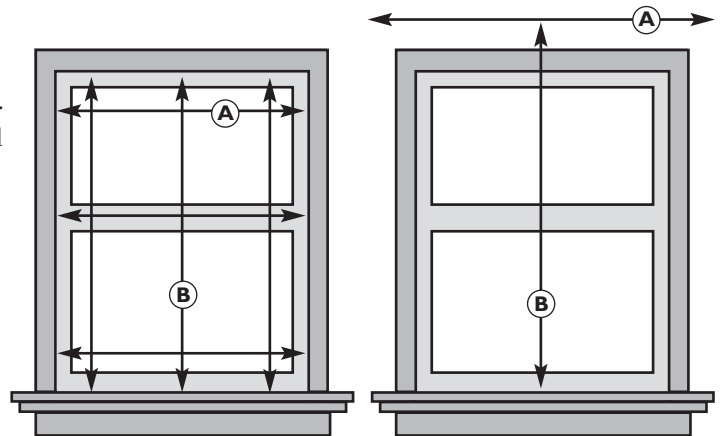

OUTSIDE OR CEILING MOUNT

Use a steel tape to measure the exact width (A) and height (B) of the area to be covered. It is recommended that the shades overlap the window by at least 1 1/2" on each side. When installation has no sill, allow the shade to overlap the bottom of the window casing by at least 1 1/2". Shade fabric will measure width indicated on the order form.

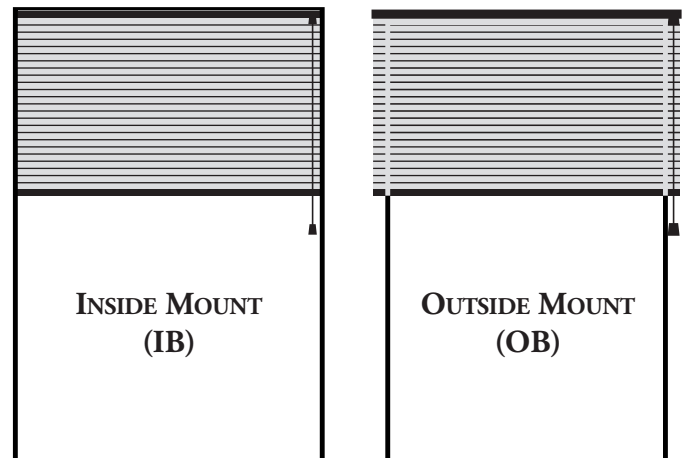

CHILD SAFETY

Be aware that it is possible for children to become entangled in window covering cords. To reduce the risk of accidents, all cords must be kept out of the reach of children. Cord cleats are an effective way to implement this essential precaution.

Mount the cord cleat at a safe height, taking into account furniture or other objects upon which a child may climb. Then, after each use of the shade, simply wrap the excess cord around the cleat.

Cord cleats are included with every Kensington Pleated Shade. Please use them.



CARING FOR SHADES

While beautiful and pleasing to the eye, all our products are designed to be durable, easily cared for and easily cleaned. Our non-woven fabrics are inherently anti-static and repel dust but occasional feather dusting or vacuuming may be necessary to keep the fabrics clean and bright.

Spills and stains can be lightly blotted with a cloth or damp sponge. More difficult stains may require soaking in water with mild soap. For this, remove the shades from the window and submerge, soak and rub lightly. Lay flat to dry or place back in window and raise tightly to recrisp pleats. Please test any stronger cleaners on an unobtrusive portion of the shade.

LIFETIME LIMITED WARRANTY

The Kensington Pleated Shades will be free from defects in materials and workmanship for as long as the original purchaser owns the product, provided that the product was installed properly and in accordance with the pleated shade installation instructions. The limited lifetime warranty is extended to the original purchaser only, in the original window for which it was intended.



The warranty does not include any conditions or damages resulting from accidents, alterations, misuse, or failure to follow printed instructions on installation, cleaning and care, or repairs. This warranty also does not apply to conditions resulting from normal wear and tear. **THIS WARRANTY IS EXCLUSIVE AND IN LIEU OF ALL OTHER OBLIGATIONS, LIABILITIES OR WARRANTIES.** In no event shall Kensington or its licensed fabricators or distributors be liable for **INCIDENTAL OR CONSEQUENTIAL DAMAGES**, or for any other damage. In some states, exclusion for incidental or consequential damages are not allowable.

KENSINGTON

WINDOW EXPRESSIONS™

Pleated Shade Order Form

Account Name: _____ Date: _____ Ship to: _____
 Account Number: _____ Contact: _____ Address: _____
 PO #: _____ Fax #: _____ City/State/Zip: _____
 Sidemark: _____ Phone #: _____ Contact Phone: _____

Special Notes: _____

Line # / Tag Name	Pattern/ Sku#*	Measurements in inches		Mount (IB or OB)	Control Side (L or R)	Options		Additional Requests	
		Width	Length			Continuous Cord	Top-Down/Bottom-Up	Hold Down brackets	Extension Brackets
1									
2									
3									
4									
5									
6									
7									
8									
9									
10									

**Please note that fabric dye lots may vary slightly from order to order.*

