



**KENSINGTON**  
WINDOW EXPRESSIONS™



Product Reference & Price Guide

# Honeycomb Shades

May 2010

## TABLE OF CONTENTS

Honeycomb Shades Program Summary .....	2
Fabric Collections .....	3
Lift Systems and Specialty Options .....	4-5
How to Order .....	6
Shade Specifications .....	7
Arch & Quarter Circles Specifications .....	8
Ascent Motorized Shade Specifications .....	9

### ARISTOCRAT PRICE GRIDS:

$\frac{3}{4}$ " Single Cell - Semi-Sheer .....	10
$\frac{3}{8}$ " Single Cell - Blackout .....	10
$\frac{3}{4}$ " Single Cell - Blackout .....	10
$\frac{3}{4}$ " Single Cell - Textures .....	11
$\frac{3}{4}$ " Single Cell - Linen .....	11
$\frac{3}{8}$ " Soft Double Cell .....	12

### ABBEY COURT PRICE GRIDS:

$\frac{1}{2}$ " Double Cell - Translucent .....	13
$\frac{3}{8}$ " Single Cell - Translucent .....	14
$\frac{3}{4}$ " Single Cell - Translucent .....	14
$\frac{3}{8}$ " Double Cell - Translucent .....	15
$\frac{3}{8}$ " Double Cell - Flame Resistant .....	16

### ANDOVER PRICE GRIDS:

$\frac{1}{2}$ " Single Cell - Translucent .....	17
---	----

### LONGITUDE PRICE GRIDS:

Longitude Features, Options & Measurements .....	18
Longitude Pricing Grids .....	19

### ARCHES AND QUARTER CIRCLE Price Grids .....

Measuring Instructions .....	24
Template Preparation Guidelines .....	24
Measuring for Arches & Quarter Circles .....	24
Finished Dimensions & Rail Measurements .....	25
Mounting & Cut-Outs Information .....	25
Stacking Heights .....	26
Ascent Motorized Options & Specifications .....	27-28
Energy Efficiency & Light Control Data .....	29
Honeycomb Shades Order Form .....	30
Longitude Honeycomb Shades Order Form .....	31
Child Safety .....	32
Caring for Shades .....	32
Warranty .....	32

## *Kensington Honeycomb Shades Program Summary*

- Available in a wide array of fabric styles and unique colors to compliment any home décor.
- Colors stay true even in the face of direct sunlight.
- A variety of light control and privacy options allow the homeowner to keep their home comfortable at all times.
- Honeycomb Shades protect interior home furnishings from harmful Ultra-Violet rays.
- The insulating properties of Honeycomb Shades improve a home's energy efficiency.
- A neutral backing provides an attractive, uniform look from the outside.
- In addition to Standard Rectangular Shades, Kensington offers a wide selection of unique lifting systems and specialty options including:
  - Ascent Motorized System, Standard and Top-Down option
  - Longitude Vertical System
  - Standard Continuous Cord System
  - Deluxe Cordless Lift System and Top-Down/Bottom-Up Cordless
  - Two-on-One Headrail
  - Two-on-One Headrail with the Standard Continuous Cord System
  - Top-Down and Top-Down/Bottom-Up Shades
  - Day-Night Shades
  - Top-Down Arches
  - Moveable and Stationary Fan Style Arches
  - Moveable and Stationary Quarter Circles
- Reliable Standard hardware system includes color coordinated components.



## FABRIC COLLECTIONS

### ARISTOCRAT HONEYCOMB SHADES

- 3/4" Single Cell - Semi-Sheer
  - Soft, beautiful fabric that is perfect for Day-Night Shades.
  - Available in six colors.
- 3/8" Single Cell and 3/4" Single Cell - Blackout
  - These fabrics provide the highest level of light and privacy control which makes them perfect for bedrooms or media rooms.
  - Available in seven colors and six colors respectively.
- 3/8" Single Cell - Textures
  - Masculine prints make these Honeycomb fabrics fashionable and appealing.
  - Two textures available in four colors each.
- 3/4" Single Cell - Linen
  - Classic Linen appearance will dress up any window with these warm subtle colors.
  - Available in five colors.
- 3/8" Soft Double Cell
  - This fabric is soft and silky and adds a touch of elegance to any room décor.
  - Available in 14 colors.

### ABBEY COURT HONEYCOMB SHADES

- 1/2" Double Cell Translucent
  - This high quality fabric is perfect for any application, pair it with the Deluxe Cordless Lift System for the ultimate in child safety.
  - Available in 12 colors.
- 3/8" Single Cell and 3/4" Single Cell - Translucent
  - The suede-like appearance of these fabrics has a soft appeal that will add warmth to any room.
  - Available in 16 and 12 colors respectively.
- 3/8" Double Cell Translucent
  - This fabric is available in our broadest color palette with 34 colors to choose from.
- 3/8" Double Cell - Flame Resistant
  - This fabric meets National Fire Code Standards for window treatments including: NFPA 701, Code 19, California ADM, The Department of Transportation Motor Vehicles Safety and Standards 302 for Flammability of Interior Materials.
  - Available in five colors.

### ANDOVER HONEYCOMB SHADES

- 1/2" Single Cell - Translucent
  - This fabric will dress up any window. Make it a Top-Down - Bottom-Up for greater light control and privacy options.
  - Available in 15 colors.

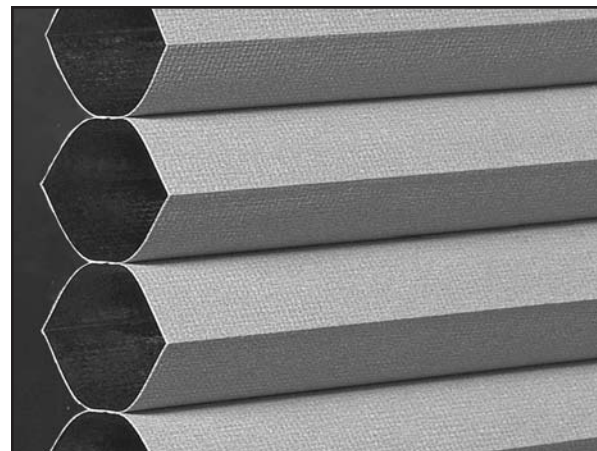

**ARISTOCRAT  
3/4" SINGLE CELL - BLACKOUT**

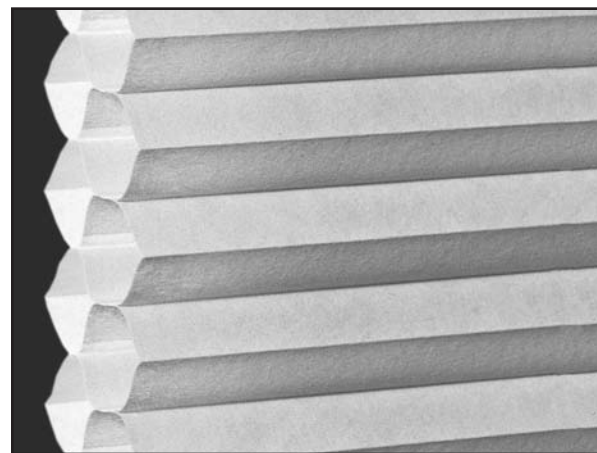

**ABBEY COURT  
1/2" DOUBLE CELL - TRANSLUCENT**

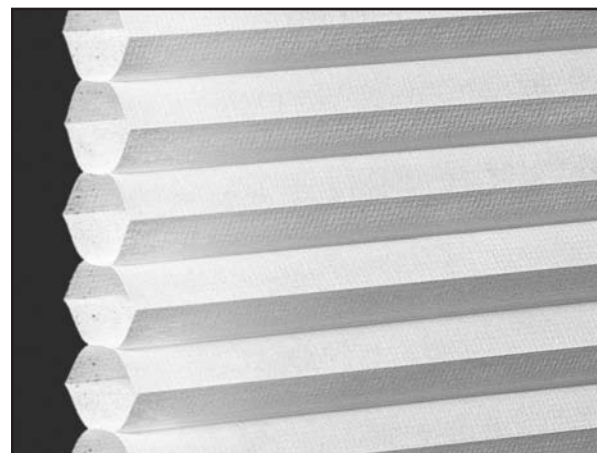

**ANDOVER  
1/2" SINGLE CELL - TRANSLUCENT**

## FEATURES AND OPTIONS

**STANDARD  
RECTANGULAR**

Traditional cord operated Honeycomb Shade that raises from the bottom up and stacks at the top.

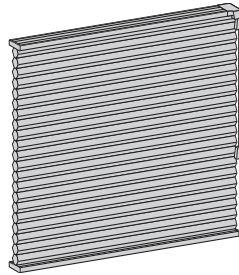

STANDARD RECTANGULAR

**CONTINUOUS  
CORD SYSTEM**

Cord design ensures the shade will open and close smoothly and evenly. The cord is shorter than the traditional dangling cord, making for a neater appearance. A special clutch system keeps the shade at the exact height desired. Ideal option for larger shades, eliminating long, cumbersome dangling cords.

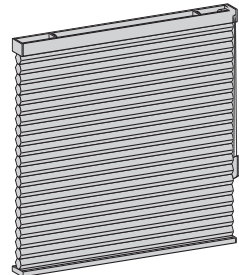

CONTINUOUS CORD

**DELUXE CORDLESS  
LIFT SYSTEM**

Stylish cordless system eliminates the traditional exposed cord and allows easy adjustment by lifting or lowering the shade by hand. Eliminates danger of dangling cords to children and pets. Also available in Top-Down/Bottom-Up Cordless.

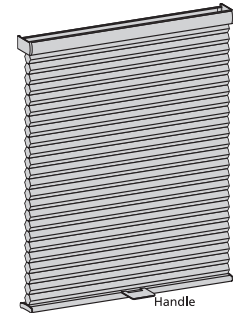
DELUXE CORDLESS  
LIFT SYSTEM**TOP-DOWN**

Ensuring privacy while allowing natural light in, this top-down shade is a lovely enhancement to any room. When completely open, this shade stacks neatly at the bottom of the window.

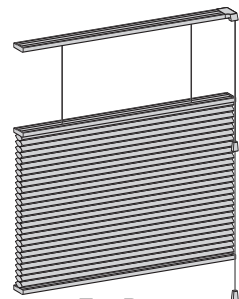

TOP-DOWN

**TOP-DOWN/  
BOTTOM-UP**

This shade can be opened from both the top and the bottom. Right and left hand controls move the middle and bottom rails to raise and lower the shade. This style is ideal for letting natural light in through the top and preserving privacy below. It also allows light to flood a room by opening completely from the bottom up.

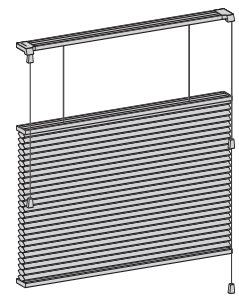

TOP-DOWN/BOTTOM-UP

**DAY-NIGHT**

This style shade utilizes two different fabrics on one shade. A translucent fabric is used on the top and a room-darkening fabric on the bottom, connected by a moving rail. This shade provides a variety of light control and privacy options.

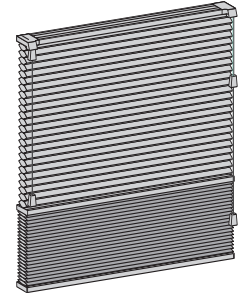

DAY-NIGHT

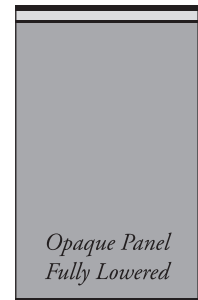
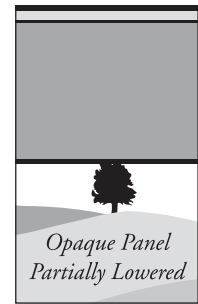
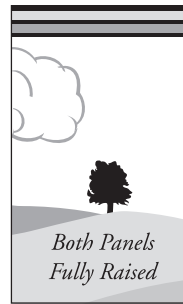
**AVAILABLE FABRIC COMBINATIONS  
FOR DAY-NIGHT SHADES**

The fabric combinations for Day-Night Shades are restricted due to hardware compatibility. Please see the following combinations that can be done with a Day-Night Shade.

Any two fabrics within this list can be paired together for a Day-Night Shade:

- Aristocrat 3/4" Single Cell – Semi-Sheer
- Aristocrat 3/4" Single Cell – Blackout
- Aristocrat 3/4" Single Cell – Linen
- Abbey Court 1/2" Double Cell – Translucent
- Abbey Court 3/4" Single Cell – Translucent

Any two fabrics within this list can be paired together for a Day-Night Shade:

- Aristocrat 3/8" Single Cell – Blackout – *Bottom Panel Only*
- Aristocrat 3/8" Single Cell – Textures
- Abbey Court 3/8" Single Cell – Translucent
- Abbey Court 3/8" Double Cell – Translucent
- Abbey Court Flame Resistant – *Bottom Panel Only*
- Andover 1/2" Single Cell - Translucent

FEATURES AND OPTIONS

**TOP-DOWN ARCH**

This fashionable shade covers almost all arched windows. It is *fully operable* and easy to maneuver using a tension cord. *Template required for all top-down arches.*

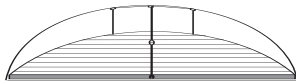
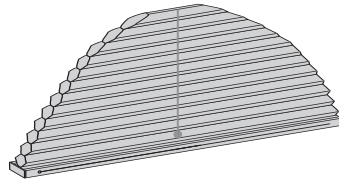

ARCH LOWERS FROM TOP

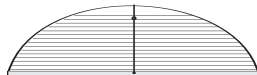

EYEBROW WINDOWS

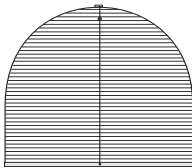

BULLET-SHAPED WINDOWS

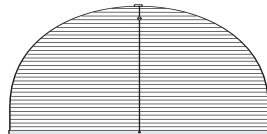

PALLADIUM WINDOWS

**MOVEABLE ARCH**

The starburst design is ideal for any *perfect arch* opening and is fully operable. Not only will it block unwanted light from those hard-to-reach windows, this specialty shade will add elegance to any room. Only available as a perfect arch.

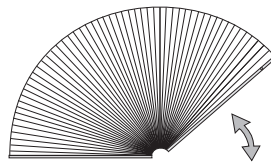

**TWO-ON-ONE HEADRAIL**

For very large single windows or two large windows side-by-side, this specialty shade provides the appearance of a single shade, with two sections operating independently. *Also available with Standard Continuous Cord System.*

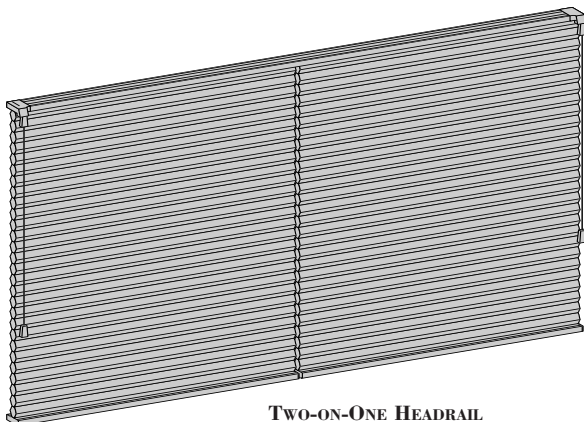

TWO-ON-ONE HEADRAIL

**STATIONARY ARCH**

The classic starburst design can be ordered stationary to fit almost any arch dimensions. *Template required for all imperfect arches.*

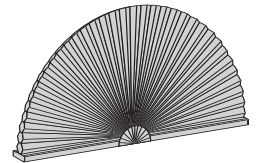

**MOVEABLE QUARTER CIRCLE**

This specialty shade is a beautiful accent for a quarter circle window. It is *fully operable* to control the amount of light entering a room. The height must equal the width.

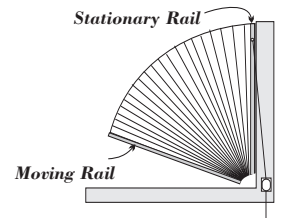

**STATIONARY QUARTER CIRCLE**

The stationary quarter circle provides constant light control for those hard-to-reach windows while adding a touch of style. The height must equal the width.

**ASCENT MOTORIZED SHADES**

Perfect for hard-to-reach windows, the battery operated remote control system will allow you to control shades with the touch of a button. Available as Standard or Top-Down, the Ascent Motorized system eliminates dangling cords and the hazards associated for children and pets. For more details on this system refer to page 27.

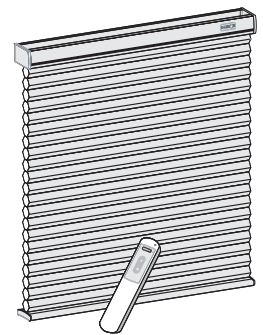

STANDARD

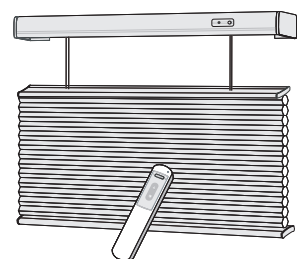

TOP-DOWN

HOW TO ORDER

The total retail price for a Honeycomb Shade is determined by the following information:

- Fabric selection
- The size of the shade ordered
- Options requested

**FABRIC SELECTION** - Each fabric uses a separate price chart located in the pricing section, pages 9 - 17 and 19 - 23.

- **Size Limitations:** Some options are only available in restricted sizes.

**SIZE OF SHADE** - On the appropriate price chart, the shade's base price is determined by the size of the shade.

- Round **UP** the shade's measured width and height to the nearest width and height dimensions on the chart.
- Locate the shade's base price - follow down the column under the shade's rounded-up width until it crosses the line of prices for the shade's rounded-up height. Where the two intersect is the shade's correct base price.

**REQUESTED OPTIONS** - Below each price chart is information for that fabric's available options. Add the appropriate **surcharges** to the shade's base price to arrive at the shade's total price.

**ORDERING TIPS** - Use the order forms on pages 30 and 31 when ordering Honeycomb Shades:

- **Size Limitations:** Some options are only available in restricted sizes. See pages 7 and 8 for details by fabric.
- **Day-Night Shade Fabric Restrictions:** Fabric combinations are limited to two fabric groups. Refer to the appropriate specifications page for details.
- **Continuous Cord Recommendations:** Large shades, within the boxed area of the price charts, are easier to operate using a continuous cord system.
- Be sure to use exact width and height dimensions when ordering.

**PRICING EXAMPLE** - Determine the final price for the following shade (*Fig. 1*):

- Honeycomb Shade
- Fabric: Abbey Court 3/4" Single Cell Translucent
- Size: 49" x 71"
- Options: Deluxe Continuous Cord

1. Locate the appropriate price chart, **Price Group A5** on page 14.
2. Round **UP** the shade's measurements to the nearest width and height on the chart, **54" x 72"**.
3. Find the correct **base price**, where the rounded-up width price column crosses the rounded-up height price line. . . . . **\$345.00**
4. Add the **surcharge** for Deluxe Continuous Cord System from the corresponding rounded-up width price column . . . . . **+68.00**
5. Add the three together for final price. . . . . **\$413.00**

PRICING EXAMPLE

14 KENSINGTON HONEYCOMB SHADES

---

PRICE GROUP **A5** **ABBEE COURT** • STANDARD RECTANGULAR  
 3/4" SINGLE CELL - TRANSLUCENT  
 3/8" SINGLE CELL - TRANSLUCENT

Width To	24"	30"	36"	42"	48"	54"	60"	66"	72"	84"	96"	108"	120"	132"	144"
36"	125	142	162	182	201	216	235	255	273	311	351	390	430	468	506
42"	136	155	177	201	220	239	262	284	305	348	394	437	483	526	571
48"	143	167	191	216	237	259	284	308	331	379	428	476	526	575	621
54"	152	175	202	228	255	279	304	330	355	407	462	514	570	620	673
60"	164	188	219	245	274	302	329	359	387	446	503	561	621	677	738
66"	174	203	234	265	295	325	357	409	419	482	546	609	673	737	799
72"	184	216	251	285	318	345	376	404	444	510	579	648	715	783	848
78"	195	228	265	301	338	372	408	446	482	554	630	703	779	851	925
84"	203	241	279	318	357	394	432	472	510	588	666	745	827	904	982
90"	213	252	294	334	377	416	458	500	542	624	709	793	877	961	1045
96"	221	265	306	351	396	437	481	525	568	656	747	834	925	1013	1102
108"	241	286	334	382	432	479	525	575	623	719	815	914	1014	1110	1208
120"	263	312	368	422	476	528	581	635	689	795	905	1014	1124	1231	1340

Continuous Cord System recommended for sizes within boxed area.

**LIFT SYSTEM SURCHARGES (add to Standard Rectangular price)**

WIDTH TO >	24"	30"	36"	42"	48"	54"	60"	66"	72"	84"	96"	108"	120"	132"	144"
Standard Continuous Cord	50	55	60	62	66	68	71	74	79	84	92	98	103	109	118
Deluxe Cordless*	56	60	66	69	72	77	83	88	93	100	108	114			
Ascent Motorized	178	182	187	194	204	210	217	228	234	247	254	264	266		

**SPECIALTY SHADE SURCHARGES (add to Standard Rectangular price)**

Top Down Ascent Motorized .....Price shade, add Ascent Motorized surcharge and add \$86.

Two-on-One Headrail.....Price as two individual shades and add \$44.

Two-on-One Headrail with Standard Continuous Cord .....Price as two individual shades, add Standard Continuous Cord surcharges for each and add \$44.

Top-Down / Bottom-Up .....Add \$75.

Top-Down Only .....Add \$75.

Day-Night .....Price as two separate shades using overall dimensions and add together.  
 NOTE: Please see available fabric combinations on page 5.

Top-Down/Bottom-Up Cordless .....Add \$72 to standard shade cost + Cordless Surcharge.

Fig. 1

IMPORTANT ORDERING INFORMATION

In addition to the correct price, all orders must include the following information:

- Fabric selection
- Color name and color number
- All options requested
- Position of controls, left or right side
- Accurate measurements for the shade's width and height
- Additional required dimensions for specialty shape applications. Template required. (*See page 24*)
- Type of mounting required:
  - Inside Mount (IB)
  - Outside Mount (OB)
  - End Mount (EM)
- Desired window/wall clearance
- Other options such as hold-down brackets

SHADE SPECIFICATIONS

		Standard Rectangular	Deluxe Continuous Cord	Standard Continuous Cord	Deluxe and TD/BU Cordless	2-on-1 Headrail	2-on-1 with Standard Continuous Cord	Top-Down & Top-Down / Bottom-Up	Day - Night	** Longitude
<b>Minimum Size: All Fabrics</b>	Width: Height:	12" 8"	12" 8"	22" 8"	18" 8"	16" 8"	44" 8"	12" 12"	12" 18"	12" 24"
<b>Maximum Size: (Fabric Specific)</b>										
<b>Aristocrat 3/4" Single Cell Semi-Sheer</b>	Width: Height:	144" 120"	144" 120"	144" 120"	120" 84"	144" 120"	144" 120"	72" 96"	72" 96"	N/A
<b>Aristocrat 3/4" Single Cell Blackout</b>	Width: Height:	144" 120"	144" 120"	144" 120"	120" 84"	144" 120"	144" 120"	72" 80"	72" 96"	168" 120"
<b>Aristocrat 3/8" Single Cell Blackout*</b>	Width: Height:	144" 120"	144" 120"	144" 120"	N/A	144" 120"	144" 120"	72" 80"	72" 96"	N/A
<b>Aristocrat 3/4" Single Cell Linen</b>	Width: Height:	144" 120"	144" 120"	144" 120"	120" 84"	144" 120"	144" 120"	72" 96"	72" 96"	168" 120"
<b>Aristocrat 3/8" Single Cell Textures</b>	Width: Height:	144" 120"	144" 120"	144" 120"	120" 84"	144" 120"	144" 120"	72" 96"	72" 96"	N/A
<b>Aristocrat Soft Double Cell</b>	Width: Height:	96" 120"	96" 120"	96" 120"	N/A	144" 120"	144" 120"	60" 60"	72" 96"	N/A
<b>Abbey Court 1/2" Double Cell Translucent</b>	Width: Height:	144" 120"	144" 120"	144" 120"	120" 84"	144" 120"	144" 120"	72" 96"	72" 96"	N/A
<b>Abbey Court 3/4" Single Cell Translucent</b>	Width: Height:	144" 120"	144" 120"	144" 120"	120" 84"	144" 120"	144" 120"	72" 96"	72" 96"	168" 120"
<b>Abbey Court 3/8" Single Cell Translucent</b>	Width: Height:	144" 120"	144" 120"	144" 120"	120" 84"	144" 120"	144" 120"	72" 96"	72" 96"	N/A
<b>Abbey Court 3/8" Double Cell Translucent &amp; Prints</b>	Width: Height:	96" 120"	96" 120"	96" 120"	72" 84"	144" 120"	144" 120"	72" 96"	72" 96"	N/A
<b>Abbey Court 3/8" Double Cell Flame Resistant*</b>	Width: Height:	96" 120"	96" 120"	96" 120"	N/A	120" 120"	120" 120"	60" 60"	72** 96**	N/A
<b>Andover 1/2" Single Cell Translucent</b>	Width: Height:	96" 120"	96" 120"	96" 120"	96" 84"	144" 120"	144" 120"	72" 96"	72" 96"	N/A

\*Only available as the bottom panel in a Day-Night shade.

\*\*Note: For center opening or dual panel Longitude shades, specifications are per fabric panel. Center opening shades are available in widths up to 336". If width is greater than 168", it will be fabricated as two shades with a single valance piece.

## ARCHES &amp; QUARTER CIRCLES SPECIFICATIONS

		Top-Down Arch*	Moveable Arch†	Stationary Arch*	Moveable Quarter Circle'	Stationary Quarter Circle'
<b>Minimum Size: All Fabrics</b>	Width: Height:	18" 6"	18" 9"	18" 9"	9" 9"	9" 9"
<b>Maximum Size: (Fabric Specific)</b>						
<b>Aristocrat 3/4" Single Cell Semi-Sheer</b>	Width: Height:	N/A	72" 36"	72" 36"	48" 48"	48" 48"
<b>Aristocrat 3/4" Single Cell Blackout</b>	Width: Height:	84" 48"	72" 36"	72" 36"	48" 48"	48" 48"
<b>Aristocrat 3/8" Single Cell Blackout</b>	Width: Height:	84" 48"	72" 36"	72" 36"	48" 48"	48" 48"
<b>Aristocrat 3/4" Single Cell Linen</b>	Width: Height:	84" 48"	72" 36"	72" 36"	48" 48"	48" 48"
<b>Aristocrat 3/8" Single Cell Textures</b>	Width: Height:	84" 48"	72" 36"	72" 36"	48" 48"	48" 48"
<b>Aristocrat Soft Double Cell</b>	Width: Height:	N/A	N/A	60" 30"	N/A	30" 30"
<b>Abbey Court 1/2" Double Cell Translucent</b>	Width: Height:	84" 48"	72" 36"	72" 36"	48" 48"	48" 48"
<b>Abbey Court 3/4" Single Cell Translucent</b>	Width: Height:	84" 48"	72" 36"	72" 36"	48" 48"	48" 48"
<b>Abbey Court 3/8" Single Cell Translucent</b>	Width: Height:	84" 48"	72" 36"	72" 36"	48" 48"	48" 48"
<b>Abbey Court 3/8" Double Cell Translucent</b>	Width: Height:	84" 72"	72" 36"	72" 36"	48" 48"	48" 48"
<b>Abbey Court 3/8" Double Cell Flame Resistant</b>	Width: Height:	N/A	N/A	60" 30"	N/A	N/A
<b>Andover 1/2" Single Cell Translucent</b>	Width: Height:	84" 72"	72" 36"	72" 36"	48" 48"	48" 48"

*Note: Size limitations on Top-Down Arches: Though our maximum width is 84" and our maximum length is 72", there are limitations on some larger sizes due to excessive weight. If the width exceeds 66", the maximum height is 60". If the width exceeds 72", the maximum height is 48".*

\* A template is required for all Top-Down Arches and for imperfect Stationary Fan Style Arches.

† Moveable Fan Style Arches are only available as a Perfect Arch: height is 1/2 of width.

• For all Quarter Circles: the height must equal the width.

• 6 foot Optional Extension Pole . . . \$75



ASCENT MOTORIZED MAXIMUM HEIGHT CHARTS

- Note that charts differ for Standard and Top-Down shades.
- Maximum width on an End-Mount Ascent Motorized shade is 65”

**ASCENT MOTORIZED  
MAXIMUM HEIGHT CHART**

• STANDARD RECTANGULAR

Height To:	Width To:	18"	24"	30"	36"	42"	48"	54"	60"	66"	72"	78"	84"	90"	96"	102"	108"	114"	120"
	3/4" Semi-Sheer	96"	96"	96"	96"	96"	96"	96"	96"	96"	96"	90"	78"	72"	66"	60"	54"	48"	42"
3/8" Textures	96"	96"	96"	96"	96"	96"	96"	96"	96"	96"	96"	96"	96"	96"	96"	96"	96"	90"	84"
3/8" Translucent	96"	96"	96"	96"	96"	96"	96"	96"	96"	96"	96"	96"	96"	96"	96"	96"	96"	96"	90"
3/8" Blackout	96"	96"	96"	96"	96"	96"	96"	96"	96"	96"	90"	72"	60"	42"	36"	24"	18"	N/A	N/A
1/2" Double Cell	96"	96"	96"	96"	96"	96"	96"	96"	96"	96"	96"	96"	90"	78"	72"	66"	60"	54"	48"
3/4" Translucent	96"	96"	96"	96"	96"	96"	96"	96"	96"	96"	96"	96"	96"	96"	96"	96"	96"	90"	84"
3/4" Blackout	96"	96"	96"	96"	96"	96"	96"	96"	96"	96"	84"	72"	60"	48"	36"	30"	24"	18"	12"

**ASCENT MOTORIZED  
MAXIMUM HEIGHT CHART**

• TOP-DOWN

Height To:	Width To:	18"	24"	30"	36"	42"	48"	54"	60"	66"	72"	78"	84"	90"	96"	102"	108"	114"	120"
	3/4" Semi-Sheer	96"	96"	96"	96"	96"	96"	96"	96"	84"	72"	60"	48"	42"	36"	30"	24"	18"	12"
3/8" Textures	96"	96"	96"	96"	96"	96"	96"	96"	96"	96"	96"	96"	96"	90"	78"	72"	60"	54"	48"
3/8" Translucent	96"	96"	96"	96"	96"	96"	96"	96"	96"	96"	96"	96"	96"	90"	78"	72"	60"	54"	48"
3/8" Blackout	96"	96"	96"	96"	96"	96"	96"	96"	96"	96"	90"	72"	60"	42"	36"	24"	18"	N/A	N/A
1/2" Double Cell	96"	96"	96"	96"	96"	96"	96"	96"	96"	84"	72"	60"	48"	42"	30"	24"	18"	12"	12"
3/4" Translucent	96"	96"	96"	96"	96"	96"	96"	96"	96"	96"	96"	96"	84"	66"	54"	42"	36"	24"	18"
3/4" Blackout	96"	96"	96"	96"	96"	96"	96"	96"	96"	96"	84"	72"	60"	48"	36"	30"	24"	18"	12"

PRICE GROUP



**ARISTOCRAT**

- 3/4" SINGLE CELL - SEMI-SHEER
- 3/4" SINGLE CELL - BLACKOUT
- 3/8" SINGLE CELL - BLACKOUT

• STANDARD RECTANGULAR

Height To:	Width To:	24"	30"	36"	42"	48"	54"	60"	66"	72"	84"	96"	108"	120"	132"	144"
	36"	156	177	200	222	245	268	290	313	337	386	437	486	538	585	634
42"	169	191	218	244	271	297	321	348	374	431	486	542	600	654	710	
48"	183	210	241	271	299	329	357	390	421	483	548	612	678	741	804	
54"	196	225	259	292	324	356	389	425	456	527	599	669	741	810	880	
60"	214	238	275	313	348	383	418	458	496	571	649	723	803	880	955	
66"	223	253	294	333	372	410	450	490	531	612	697	781	865	945	1031	
72"	238	272	317	360	402	444	486	532	576	666	758	849	941	1032	1123	
78"	251	287	333	381	427	471	516	567	612	708	807	905	1003	1098	1197	
84"	261	301	352	402	450	498	546	600	647	752	856	957	1064	1169	1273	
90"	275	320	374	425	479	532	584	639	693	804	914	1026	1142	1253	1366	
96"	286	333	390	447	502	558	612	672	729	845	966	1082	1202	1322	1441	
108"	309	362	427	490	552	613	674	741	803	932	1064	1193	1327	1458	1591	
120"	332	394	463	531	616	668	735	807	877	1018	1161	1307	1453	1597	1733	

*Continuous Cord System recommended for sizes within boxed area.*

**LIFT SYSTEM SURCHARGES** (add to Standard Rectangular price)

WIDTH TO: >	24"	30"	36"	42"	48"	54"	60"	66"	72"	84"	96"	108"	120"	132"	144"
Standard Continuous Cord	50	55	60	62	66	68	71	74	79	84	92	98	103	109	118
Deluxe Cordless*	56	60	66	69	72	74	77	83	88	93	100	108	114		
Ascent Motorized	178	182	187	194	204	210	217	228	234	247	254	264	266		

\* 3/8" Blackout fabric is not available on the Deluxe Cordless System.

**SPECIALTY SHADE SURCHARGES** (add to Standard Rectangular price)

Top Down Ascent Motorized .....Price shade, add Ascent Motorized surcharge and add \$86.

Two-on-One Headrail.....Price as two individual shades and add \$44.

Two-on-One Headrail with Standard Continuous Cord .....Price as two individual shades, add Standard Continuous Cord surcharges for each and add \$44.

Top-Down / Bottom-Up .....Add \$75.

Top-Down Only .....Add \$75.

Day-Night .....Price as two separate shades using overall dimensions and add together.

NOTE: Please see available fabric combinations on page 5.

Top-Down/Bottom-Up Cordless .....Add \$72 to standard shade cost + Cordless Surcharge.



**ARISTOCRAT**

**3/4" SINGLE CELL - LINEN**

**3/8" SINGLE CELL - TEXTURES**

• STANDARD RECTANGULAR

Height To:	Width To:	24"	30"	36"	42"	48"	54"	60"	66"	72"	84"	96"	108"	120"	132"	144"
	36"	129	146	166	188	207	222	242	263	281	320	362	402	443	482	521
42"	141	159	182	207	227	250	270	293	314	359	406	450	498	542	588	
48"	148	172	197	222	244	267	293	317	341	390	440	491	542	593	640	
54"	156	181	208	235	263	287	313	340	366	419	476	529	587	638	693	
60"	169	194	225	252	283	311	339	370	399	459	518	578	640	697	757	
66"	179	209	241	273	304	336	367	422	432	496	562	627	693	759	823	
72"	189	218	252	287	323	356	387	443	458	525	597	667	736	806	874	
78"	201	235	273	310	349	383	420	459	496	571	648	724	802	877	953	
84"	209	248	287	327	367	406	445	486	525	605	686	768	852	931	1011	
90"	220	260	303	344	389	429	472	515	558	643	730	816	904	990	1076	
96"	228	273	316	362	407	450	495	541	585	676	769	859	953	1043	1135	
108"	248	294	344	393	445	494	541	593	641	740	839	941	1044	1143	1244	
120"	271	321	379	435	491	544	598	654	710	819	933	1044	1158	1268	1380	

*Continuous Cord System recommended for sizes within boxed area.*

**LIFT SYSTEM SURCHARGES** (add to Standard Rectangular price)

WIDTH TO: >	24"	30"	36"	42"	48"	54"	60"	66"	72"	84"	96"	108"	120"	132"	144"
Standard Continuous Cord	50	55	60	62	66	68	71	74	79	84	92	98	103	109	118
Deluxe Cordless*	56	60	66	69	72	74	77	83	88	93	100	108	114		
Ascent Motorized	178	182	187	194	204	210	217	228	234	247	254	264	266		

**SPECIALTY SHADE SURCHARGES** (add to Standard Rectangular price)

- Top Down Ascent Motorized .....Price shade, add Ascent Motorized surcharge and add \$86.
- Two-on-One Headrail.....Price as two individual shades and add \$44.
- Two-on-One Headrail with  
Standard Continuous Cord .....Price as two individual shades, add Standard Continuous Cord surcharges for each and add \$44.
- Top-Down / Bottom-Up .....Add \$75.
- Top-Down Only .....Add \$75.
- Day-Night .....Price as two separate shades using overall dimensions and add together.  
NOTE: Please see available fabric combinations on page 5.
- Top-Down/Bottom-Up Cordless .....Add \$72 to standard shade cost + Cordless Surcharge.

PRICE GROUP

**A3**

**ARISTOCRAT**  
**3/8" SOFT DOUBLE CELL**

• STANDARD RECTANGULAR

Height To:	Width To:	24"	30"	36"	42"	48"	54"	60"	66"	72"	84"	96"
	36"	141	160	181	203	225	245	265	285	307	353	397
42"	151	172	196	222	245	268	292	316	338	390	440	
48"	162	187	214	240	265	292	317	344	372	426	482	
54"	172	199	228	257	286	314	343	374	403	463	525	
60"	182	212	245	274	306	338	369	402	435	498	565	
66"	194	225	261	294	328	362	395	430	464	534	608	
72"	203	237	274	311	349	384	421	458	495	571	650	
78"	217	251	289	326	369	406	446	488	528	607	691	
84"	221	261	304	344	387	427	470	512	553	638	727	
90"	231	274	319	362	408	451	494	540	586	676	767	
96"	240	285	331	378	426	470	518	565	613	707	805	
108"	261	308	360	411	466	515	567	618	672	777	884	
120"	279	334	392	446	506	561	617	675	730	845	963	

*Continuous Cord System recommended for sizes within boxed area.*

**LIFT SYSTEM SURCHARGES** (add to Standard Rectangular price)

WIDTH TO: >	24"	30"	36"	42"	48"	54"	60"	66"	72"	84"	96"
Standard Continuous Cord	50	55	60	62	66	68	71	74	79	84	92

**SPECIALTY SHADE SURCHARGES** (add to Standard Rectangular price)

Two-on-One Headrail.....Price as two individual shades and add \$44.

Two-on-One Headrail with Standard Continuous Cord .....Price as two individual shades, add Standard Continuous Cord surcharges for each and add \$44.

Top-Down / Bottom-Up .....Add \$75.

Top-Down Only .....Add \$75.

Day-Night .....Price as two separate shades using overall dimensions and add together.

NOTE: Please see available fabric combinations on page 5.



**ABBEY COURT**  
**1/2" DOUBLE CELL - TRANSLUCENT**

• STANDARD RECTANGULAR

Height To:	Width To:	24"	30"	36"	42"	48"	54"	60"	66"	72"	84"	96"	108"	120"	132"	144"
	36"	131	149	169	188	209	226	244	264	282	322	364	405	443	482	520
42"	139	160	181	207	227	249	269	292	314	356	404	447	494	538	581	
48"	150	173	198	222	245	269	292	318	344	393	443	490	544	593	641	
54"	158	183	211	238	265	290	317	345	374	427	482	538	593	646	700	
60"	169	195	226	253	282	313	341	374	402	460	521	581	642	700	760	
66"	180	210	241	271	303	336	366	399	432	497	562	624	691	754	818	
72"	191	221	255	287	324	356	389	428	460	529	601	672	741	810	876	
78"	199	232	268	306	343	378	414	454	490	565	641	714	791	865	938	
84"	207	242	280	321	360	397	437	479	517	596	674	754	837	914	993	
90"	217	255	298	339	381	420	460	505	548	630	715	800	886	970	1054	
96"	226	267	311	353	398	441	483	528	574	661	752	841	930	1018	1110	
108"	245	291	341	387	439	485	531	584	631	729	827	925	1026	1127	1243	
120"	264	316	368	422	478	528	584	636	689	796	906	1014	1119	1232	1349	

*Continuous Cord System recommended for sizes within boxed area.*

**LIFT SYSTEM SURCHARGES** (add to Standard Rectangular price)

WIDTH TO: >	24"	30"	36"	42"	48"	54"	60"	66"	72"	84"	96"	108"	120"	132"	144"
Standard Continuous Cord	50	55	60	62	66	68	71	74	79	84	92	98	103	109	118
Deluxe Cordless*	56	60	66	69	72	74	77	83	88	93	100	108	114		
Ascent Motorized	178	182	187	194	204	210	217	228	234	247	254	264	266		

**SPECIALTY SHADE SURCHARGES** (add to Standard Rectangular price)

- Top Down Ascent Motorized .....Price shade, add Ascent Motorized surcharge and add \$86.
- Two-on-One Headrail.....Price as two individual shades and add \$44.
- Two-on-One Headrail with  
Standard Continuous Cord .....Price as two individual shades, add Standard Continuous Cord surcharges for each and add \$44.
- Top-Down / Bottom-Up .....Add \$75.
- Top-Down Only .....Add \$75.
- Day-Night .....Price as two separate shades using overall dimensions and add together.  
NOTE: Please see available fabric combinations on page 5.
- Top-Down/Bottom-Up Cordless .....Add \$72 to standard shade cost + Cordless Surcharge.

PRICE GROUP

A5

**ABBEY COURT**

• STANDARD RECTANGULAR

3/4" SINGLE CELL - TRANSLUCENT

3/8" SINGLE CELL - TRANSLUCENT

Height To:	Width To:	24"	30"	36"	42"	48"	54"	60"	66"	72"	84"	96"	108"	120"	132"	144"
	36"	125	142	162	182	201	216	235	255	273	311	351	390	430	468	506
42"	136	155	177	201	220	242	262	284	305	348	394	437	483	526	571	
48"	143	167	191	216	237	259	284	308	331	379	428	476	526	575	621	
54"	152	175	202	228	255	279	304	330	355	407	462	514	570	620	673	
60"	164	188	219	245	274	302	329	359	387	446	503	561	621	677	735	
66"	174	203	234	265	295	326	357	409	419	482	546	609	673	737	799	
72"	184	212	245	279	313	345	376	404	444	510	579	648	715	783	848	
78"	195	228	265	301	338	372	408	446	482	554	630	703	779	851	925	
84"	203	241	279	318	357	394	432	472	510	588	666	745	827	904	982	
90"	213	252	294	334	377	416	458	500	542	624	709	793	877	961	1045	
96"	221	265	306	351	396	437	481	525	568	656	747	834	925	1013	1102	
108"	241	286	334	382	432	479	525	575	623	719	815	914	1014	1110	1208	
120"	263	312	368	422	476	528	581	635	689	795	905	1014	1124	1231	1340	

*Continuous Cord System recommended for sizes within boxed area.*

**LIFT SYSTEM SURCHARGES** (add to Standard Rectangular price)

WIDTH TO: >	24"	30"	36"	42"	48"	54"	60"	66"	72"	84"	96"	108"	120"	132"	144"
Standard Continuous Cord	50	55	60	62	66	68	71	74	79	84	92	98	103	109	118
Deluxe Cordless*	56	60	66	69	72	74	77	83	88	93	100	108	114		
Ascent Motorized	178	182	187	194	204	210	217	228	234	247	254	264	266		

**SPECIALTY SHADE SURCHARGES** (add to Standard Rectangular price)

Top Down Ascent Motorized .....Price shade, add Ascent Motorized surcharge and add \$86.

Two-on-One Headrail.....Price as two individual shades and add \$44.

Two-on-One Headrail with Standard Continuous Cord .....Price as two individual shades, add Standard Continuous Cord surcharges for each and add \$44.

Top-Down / Bottom-Up .....Add \$75.

Top-Down Only .....Add \$75.

Day-Night .....Price as two separate shades using overall dimensions and add together.

NOTE: Please see available fabric combinations on page 5.

Top-Down/Bottom-Up Cordless .....Add \$72 to standard shade cost + Cordless Surcharge.



**ABBEY COURT**  
**3/8" DOUBLE CELL - TRANSLUCENT**

• STANDARD RECTANGULAR

Height To:	Width To:	24"	30"	36"	42"	48"	54"	60"	66"	72"	84"	96"
	36"	116	133	150	169	187	203	221	237	255	292	329
42"	126	144	162	186	203	222	242	261	282	324	366	
48"	134	154	177	199	221	242	263	286	309	353	399	
54"	142	165	190	214	237	260	284	311	334	383	435	
60"	152	175	203	227	253	280	306	333	360	414	469	
66"	161	187	215	244	272	301	328	357	386	443	504	
72"	169	196	227	259	288	320	349	381	412	474	540	
78"	177	207	240	271	307	337	371	405	437	504	573	
84"	183	217	252	286	322	353	390	425	459	529	604	
90"	192	227	264	301	339	374	410	448	486	561	636	
96"	199	236	275	313	353	390	429	470	508	588	669	
108"	217	256	299	341	386	428	470	515	558	645	734	
120"	232	276	325	371	420	466	512	561	607	701	799	

*Continuous Cord System recommended for sizes within boxed area.*

**LIFT SYSTEM SURCHARGES** (add to Standard Rectangular price)

WIDTH TO: >	24"	30"	36"	42"	48"	54"	60"	66"	72"	84"	96"
Standard Continuous Cord	50	55	60	62	66	68	71	74	79	84	92
Deluxe Cordless	56	60	66	69	72	74	77	83	88	93	100

**SPECIALTY SHADE SURCHARGES** (add to Standard Rectangular price)

Two-on-One Headrail.....Price as two individual shades and add \$44.

Two-on-One Headrail with Standard Continuous Cord.....Price as two individual shades, add Standard Continuous Cord surcharges for each and add \$44.

Top-Down / Bottom-Up .....Add \$74.

Top-Down Only .....Add \$74.

Day-Night .....Price as two separate shades using overall dimensions and add together.

NOTE: Please see available fabric combinations on page 5.

Top-Down/Bottom-Up Cordless .....Add \$72 to standard shade cost + Cordless Surcharge.



**ABBEY COURT**  
**DOUBLE CELL - FLAME RESISTANT**

• STANDARD RECTANGULAR

Height To:	Width To:	24"	30"	36"	42"	48"	54"	60"	66"	72"	84"	96"
	36"	148	168	188	210	233	253	275	297	318	364	410
42"	160	179	204	230	253	276	303	326	352	402	455	
48"	169	194	221	248	275	302	328	356	386	441	500	
54"	181	206	236	265	297	325	353	387	417	478	543	
60"	190	218	255	284	316	349	381	417	450	517	585	
66"	202	233	268	303	339	374	408	447	483	555	631	
72"	211	245	284	324	360	398	436	477	516	593	676	
78"	222	260	299	340	383	421	463	506	548	632	719	
84"	230	271	316	357	402	444	487	534	577	665	758	
90"	241	284	329	376	422	469	513	562	611	704	800	
96"	251	297	345	393	444	490	539	590	639	738	842	
108"	272	324	378	431	486	538	592	649	701	812	925	
120"	292	349	410	469	529	586	646	707	765	886	1009	

Continuous Cord System recommended for sizes within boxed area.

Continuous Cord System required for sizes within boxed area.

**LIFT SYSTEM SURCHARGES** (add to Standard Rectangular price)

WIDTH TO: >	24"	30"	36"	42"	48"	54"	60"	66"	72"	84"	96"
Standard Continuous Cord	50	55	60	62	66	68	71	74	79	84	92

**SPECIALTY SHADE SURCHARGES** (add to Standard Rectangular price)

Two-on-One Headrail.....Price as two individual shades and add \$44.

Two-on-One Headrail with Standard Continuous Cord.....Price as two individual shades, add Standard Continuous Cord surcharges for each and add \$44.

Top-Down / Bottom-Up .....Add \$74.

Top-Down Only .....Add \$74.

Day-Night .....Price as two separate shades using overall dimensions and add together.

NOTE: Please see available fabric combinations on page 5.





**ANDOVER**  
**1/2" SINGLE CELL - TRANSLUCENT**

• STANDARD RECTANGULAR

Height To:	Width To:	24"	30"	36"	42"	48"	54"	60"	66"	72"	84"	96"
	36"	111	126	142	160	177	194	210	225	242	278	313
42"	119	137	154	176	194	211	230	248	267	307	347	
48"	127	148	168	190	210	230	251	272	292	336	381	
54"	135	157	180	203	226	248	269	295	317	364	413	
60"	145	167	194	217	241	267	291	317	343	393	446	
66"	153	177	206	232	259	284	311	340	366	421	479	
72"	161	187	217	246	275	303	333	362	391	450	513	
78"	168	198	227	257	291	321	352	385	416	478	544	
84"	175	206	240	272	306	336	370	404	436	502	573	
90"	183	215	251	284	321	355	390	425	462	534	605	
96"	190	225	261	298	336	371	409	446	482	558	635	
108"	206	244	284	324	367	406	447	487	529	612	697	
120"	219	263	309	352	399	443	487	532	576	666	758	

**LIFT SYSTEM SURCHARGES** (add to Standard Rectangular price)

WIDTH TO: >	24"	30"	36"	42"	48"	54"	60"	66"	72"	84"	96"
Standard Continuous Cord	50	55	60	62	66	68	71	74	79	84	92
Deluxe Cordless	56	60	66	69	72	74	77	83	88	93	100

**SPECIALTY SHADE SURCHARGES** (add to Standard Rectangular price)

Two-on-One Headrail.....Price as two individual shades and add \$44.

Two-on-One Headrail with  
 Standard Continuous Cord .....Price as two individual shades, add Standard Continuous Cord surcharges for each and add \$44.

Top-Down / Bottom-Up .....Add \$74.

Top-Down Only .....Add \$74.

Day-Night .....Price as two separate shades using overall dimensions and add together.

NOTE: Please see available fabric combinations on page 5.

Top-Down/Bottom-Up Cordless .....Add \$72 to standard shade cost + Cordless Surcharge.

## LONGITUDE SHADES FEATURES, OPTIONS AND MEASUREMENTS

### LONGITUDE SHADES

- Longitude Honeycomb Shades open and close from side to side to accommodate sliding glass doors, room dividers and French doors, perfectly.
- Longitude Honeycomb Shades are available in five stacking configurations:
  - Left Stack
  - Right Stack
  - Split Stack
  - Center Stack
  - Dual Panel - is a Center Opening shade with a different fabric on each side. Each panel can fully span the width of the window.

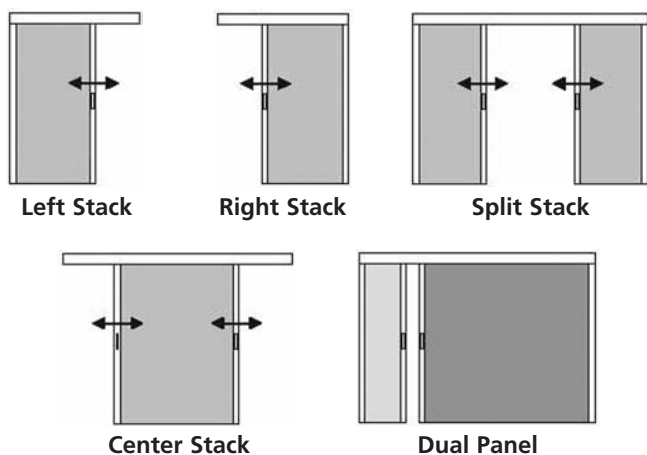

- Longitude Honeycomb Shades are available on Aristocrat 3/4" Single Cell Blackout, Aristocrat 3/4" Single Cell Linen Print and Abbey Court 3/4" Single Cell Translucent fabrics.

### SIZE SPECIFICATIONS

Minimum Width:	12"	Maximum Width:	168"
Minimum Height	24"	Maximum Height:	120"

*\*Note: For Split Stack or Dual Panel, specifications are per fabric panel.*

*\*Note: Split Stack Shades are available in widths up to 336". If width is greater than 168", it will be fabricated as two shades with a single valance piece to create the illusion of a single shade.*

### MOUNTING REQUIREMENTS

- Inside Mount: Minimum mounting depth required is 3/4"
- Flush Mount: Minimum mounting depth required  
 Aluminum Valance is 3 5/8"  
 Minimum mounting depth required  
 Alternative Wood Valance is 4"
- Outside Mount: Minimum flat vertical surface required is 5/8"
- Fabric Stacking: 6 1/2"  
*\*Note: fabric stack is determined by hardware and not by ordered width*

### FINISHED DIMENSIONS

- Inside Mount:
  - Headrail unit will measure ordered width less 3/16"
  - Shade height will measure ordered height less 1/2"
  - Valance width (non-flush) will measure ordered width plus 1 1/4"
  - Valance width (flush) will measure ordered width less 3/16"
- Outside Mount:
  - Headrail unit will measure ordered width
  - Shade height will measure ordered height
  - Valance width will measure ordered width plus 1 1/4"
  - \*width and height measurements may vary +/- 1/8".*

### NO CHARGE OPTIONS & HARDWARE INFORMATION

#### No-Charge Options

- Extension brackets
- Spacer blocks

Please note on order any options required.

#### Hardware Information

- The top and vertical rails are available in white only.
- Both the aluminum and alternative wood valances are coordinating white to the rail.
- Standard handle height ranges from 40" to 50" from bottom of moving rail; specify any desired variation.

PRICE GROUP **L1** **ARISTOCRAT Side Stack Grid**  
**3/4" SINGLE CELL - LINEN**  
**3/4" SINGLE CELL - TRANSLUCENT**

Height To:	Width To:	24"	30"	36"	42"	48"	54"	60"	66"	72"	78"	84"	96"	108"	120"	132"	144"	156"	168"
	36"	303	328	358	385	408	435	463	487	515	543	566	614	661	711	757	807	853	898
42"	323	353	386	416	443	473	505	533	564	594	621	676	729	787	839	896	947	999	
48"	344	376	413	447	477	510	545	581	613	644	677	740	798	862	919	984	1043	1099	
54"	363	402	440	478	511	547	585	624	661	696	732	801	866	937	1004	1071	1135	1199	
60"	384	425	467	508	545	586	626	668	707	748	786	863	934	1012	1083	1161	1231	1299	
66"	406	449	495	541	581	623	666	716	756	801	838	925	1003	1085	1163	1247	1323	1399	
72"	428	475	524	572	618	662	706	760	805	852	894	991	1071	1163	1246	1337	1418	1498	
78"	450	500	552	606	653	703	750	806	854	904	948	1050	1138	1237	1327	1423	1511	1599	
84"	473	526	580	638	690	740	792	851	904	957	1004	1113	1206	1311	1406	1510	1606	1698	
90"	493	550	610	672	725	780	836	900	954	1009	1062	1176	1274	1389	1492	1598	1697	1797	
96"	514	574	639	704	759	817	880	944	1004	1063	1117	1240	1343	1462	1574	1685	1791	1894	
102"	536	598	666	733	791	853	919	986	1049	1113	1167	1297	1407	1534	1650	1766	1878	1988	
108"	557	623	692	763	825	888	958	1028	1096	1161	1219	1355	1471	1601	1726	1847	1968	2081	
114"	579	648	719	793	857	924	998	1071	1143	1211	1271	1414	1535	1672	1801	1929	2053	2175	
120"	599	670	745	822	889	960	1036	1113	1186	1258	1322	1471	1597	1740	1877	2011	2141	2268	

PRICE GROUP **L2** **ARISTOCRAT Side Stack Grid**  
**3/4" SINGLE CELL - BLACKOUT**

Height To:	Width To:	24"	30"	36"	42"	48"	54"	60"	66"	72"	78"	84"	96"	108"	120"	132"	144"	156"	168"
	36"	353	388	431	469	503	536	572	609	646	683	716	780	849	913	975	1034	1100	1161
42"	383	425	471	515	555	593	636	675	720	757	796	867	949	1020	1092	1160	1234	1303	
48"	414	460	512	559	602	648	693	743	785	832	876	956	1045	1127	1207	1284	1361	1436	
54"	443	496	552	605	653	702	751	806	857	909	954	1045	1143	1234	1324	1411	1486	1566	
60"	472	529	591	650	704	758	813	870	924	985	1036	1134	1240	1340	1439	1533	1621	1701	
66"	504	566	635	699	755	815	873	937	996	1061	1116	1225	1340	1445	1556	1659	1757	1838	
72"	535	599	674	745	805	869	934	1003	1066	1137	1199	1314	1439	1551	1672	1781	1882	1968	
78"	566	633	715	792	857	926	999	1069	1137	1215	1279	1403	1538	1655	1788	1906	2008	2098	
84"	596	667	755	835	904	977	1057	1135	1208	1290	1360	1493	1638	1764	1903	2029	2133	2228	
90"	625	702	794	884	958	1035	1120	1202	1280	1366	1438	1582	1733	1868	2017	2152	2258	2358	
96"	655	734	833	927	1010	1092	1177	1267	1350	1443	1517	1672	1827	1974	2132	2276	2384	2494	
102"	683	768	871	971	1057	1144	1234	1330	1419	1516	1593	1758	1922	2077	2243	2395	2509	2630	
108"	711	801	908	1014	1105	1197	1293	1393	1486	1589	1670	1845	2017	2179	2354	2515	2639	2760	
114"	740	834	946	1057	1154	1252	1350	1456	1555	1664	1747	1931	2112	2283	2467	2639	2765	2895	
120"	767	865	984	1100	1202	1303	1406	1519	1622	1735	1824	2017	2207	2389	2578	2758	2889	3025	

**DESIGN OPTION SURCHARGES**

Center Stack .....Add \$73 to shade base price.

Split Stack .....Divide full width measurement in half,  
price as two separate units and add the two prices together.

Dual Panel .....Price as two separate units and add together

**Valance Information**

An aluminum valance comes standard with your shade order. An alternative wood valance is also available at no extra charge. Please specify on order.

Please specify valance type on your order.  
Aluminum valance height is 1 7/8"  
Alternative Wood valance height is 3 1/4"

**Valance Return Lengths**

Aluminum Valance 3 1/8"  
Alternative Wood Valance\* 3 1/4"  
*Custom return lengths available by request.*

\*Please note: Shade widths over 108" may require valance to be spliced.



Aluminum Valance



Alternative Wood Valance

## PRICE GROUP

**B 1****ARISTOCRAT**

• TOP-DOWN ARCHES

**3/4" SINGLE CELL - BLACKOUT****3/8" SINGLE CELL - BLACKOUT**

Width To:	24"	30"	36"	42"	48"	54"	60"	66"	72"	78"	84"
Perfect Arch	272	303	321	363	385	435	460	506	552	599	658
36"	352	387	405	436	452	486	501	528	552	578	601
42"	372	412	428	470	487	525	544	574	601	631	658
48"	394	436	458	500	519	550	585	617	650	682	716

## PRICE GROUP

**B 2****ARISTOCRAT**

• TOP-DOWN ARCHES

**3/4" SINGLE CELL - LINEN****3/8" SINGLE CELL - TEXTURES**

Width To:	24"	30"	36"	42"	48"	54"	60"	66"	72"	78"	84"
Perfect Arch	212	237	251	284	301	340	360	397	432	468	515
36"	275	303	317	341	354	380	392	413	432	452	471
42"	291	323	336	369	382	412	426	449	471	494	515
48"	308	341	357	390	406	430	458	483	509	534	561

## PRICE GROUP

**B 4****ABBEY COURT**

• TOP-DOWN ARCHES

**1/2" DOUBLE CELL**

Width To:	24"	30"	36"	42"	48"	54"	60"	66"	72"	78"	84"
Perfect Arch	249	278	294	332	352	398	421	464	505	548	603
36"	322	353	371	399	414	446	459	483	505	529	550
42"	340	376	391	431	447	481	498	525	550	577	603
48"	360	399	418	496	475	504	536	565	594	626	655

## PRICE GROUP

**B 5****ABBEY COURT**

• TOP-DOWN ARCHES

**3/4" SINGLE CELL****3/8" SINGLE CELL**

Width To:	24"	30"	36"	42"	48"	54"	60"	66"	72"	78"	84"
Perfect Arch	206	230	244	276	292	330	350	386	419	454	500
36"	267	294	308	331	344	369	380	401	419	439	457
42"	283	313	326	358	370	400	414	436	457	479	500
48"	299	331	347	379	394	418	444	469	494	518	545

PRICE GROUP <b>B 6</b>	<b>ABBEY COURT</b> 3/8" DOUBLE CELL 3/8" DOUBLE CELL - PRINTS	• TOP-DOWN ARCHES
---------------------------	---	-------------------

Width To:	24"	30"	36"	42"	48"	54"	60"	66"	72"	78"	84"
Perfect Arch	177	198	209	236	251	283	299	329	359	389	428
36"	229	252	263	283	294	316	325	344	359	376	390
42"	242	268	279	306	317	341	353	374	390	410	428
48"	256	283	297	325	337	357	381	401	422	444	466
60"	271	297	316	344	362	379	404	425	447		
78"	287	311	334	363	383	401	420	451			

PRICE GROUP <b>B 8</b>	<b>ANDOVER</b> 1/2" SINGLE CELL	• TOP-DOWN ARCHES
---------------------------	------------------------------------	-------------------

Width To:	24"	30"	36"	42"	48"	54"	60"	66"	72"	78"	84"
Perfect Arch	168	187	198	223	238	268	284	313	341	370	406
36"	218	238	251	269	279	301	309	326	341	357	371
42"	230	255	264	291	301	325	336	355	371	390	406
48"	244	269	283	309	321	340	362	382	401	421	443
60"	256	282	299	326	340	363	383	404	425		
78"	268	297	317	347	360	385	405	429			

## PRICE GROUP

**C1****ARISTOCRAT**

**3/4" SEMI-SHEER**  
**3/4" SINGLE CELL - BLACKOUT**  
**3/8" SINGLE CELL - BLACKOUT**

- FAN STYLE ARCHES
- QUARTER CIRCLES

Width To:	24"	30"	36"	42"	48"	54"	60"	66"	72"
Moveable Arch	298	337	383	436	519	582	655	734	821
Stationary Arch	207	237	271	309	370	424	479	542	609
Moveable Quarter Circle	370	421	478	539	609				
Stationary Quarter Circle	271	309	352	402	458				

## PRICE GROUP

**C2****ARISTOCRAT**

**3/4" SINGLE CELL - LINEN**  
**3/8" SINGLE CELL - TEXTURES**

- FAN STYLE ARCHES
- QUARTER CIRCLES

Width To:	24"	30"	36"	42"	48"	54"	60"	66"	72"
Moveable Arch	232	264	300	341	406	456	514	574	641
Stationary Arch	162	187	212	241	290	331	376	425	476
Moveable Quarter Circle	290	330	374	422	476				
Stationary Quarter Circle	211	241	275	314	359				

## PRICE GROUP

**C3****ARISTOCRAT**

**3/8" SOFT DOUBLE CELL**

- FAN STYLE ARCHES
- QUARTER CIRCLES

Width To:	24"	30"	36"	42"	48"	54"	60"	66"	72"
Stationary Arch	163	185	212	242	289	332	375		
Stationary Quarter Circle	193	22							

## PRICE GROUP

**C4****ABBEY COURT**

**1/2" DOUBLE CELL**

- FAN STYLE ARCHES
- QUARTER CIRCLES

Width To:	24"	30"	36"	42"	48"	54"	60"	66"	72"
Moveable Arch	259	292	333	378	450	505	569	636	711
Stationary Arch	180	206	236	268	321	367	416	470	528
Moveable Quarter Circle	339	386	437	493	558				
Stationary Quarter Circle	234	268	306	348	397				

PRICE GROUP **C5** **ABBEY COURT** • FAN STYLE ARCHES  
 3/4" SINGLE CELL • QUARTER CIRCLES  
 3/8" SINGLE CELL

Width To:	24"	30"	36"	42"	48"	54"	60"	66"	72"
Moveable Arch	226	256	291	331	394	443	499	557	623
Stationary Arch	157	181	206	234	281	322	365	412	462
Moveable Quarter Circle	281	320	364	409	462				
Stationary Quarter Circle	205	234	267	305	348				

PRICE GROUP **C6** **ABBEY COURT** • FAN STYLE ARCHES  
 3/8" DOUBLE CELL • QUARTER CIRCLES  
 3/8" DOUBLE CELL - PRINTS

Width To:	24"	30"	36"	42"	48"	54"	60"	66"	72"
Moveable Arch	194	219	249	283	337	379	427	477	534
Stationary Arch	135	154	176	200	241	275	311	352	397
Moveable Quarter Circle	241	274	311	351	397				
Stationary Quarter Circle	176	200	229	261	298				

PRICE GROUP **C7** **ABBEY COURT** • FAN STYLE ARCHES  
 FLAME RESISTANT

Width To:	24"	30"	36"	42"	48"	54"	60"	66"	72"
Stationary Arch	172	196	222	251	301	343	389		

PRICE GROUP **C8** **ANDOVER** • FAN STYLE ARCHES  
 1/2" SINGLE CELL • QUARTER CIRCLES

Width To:	24"	30"	36"	42"	48"	54"	60"	66"	72"
Moveable Arch	184	207	237	269	321	360	405	454	506
Stationary Arch	129	146	168	191	229	261	297	334	376
Moveable Quarter Circle	229	260	295	333	376				
Stationary Quarter Circle	167	191	218	248	283				

## MEASURING INSTRUCTIONS

Accurate measurements are essential, for both correct pricing and proper fit. Use only a hard-edged ruler or steel tape, never a cloth tape. For *inside mounts*, width measurements (A) should be rounded **down** to the nearest 1/8" to prevent blind from binding against the window casing.

### INSIDE MOUNT

Use a steel tape to measure the opening width (A) at three different places, and use the narrowest dimension when ordering. Be exact! The factory will make the shade 3/8" narrower so it will not rub against the window casing. Measure the height (B) of the window casing from the top (Soffit) down to the sill.

### OUTSIDE MOUNT

Use a steel tape to measure the exact width (A) and height (B) of the area to be covered. It is recommended that the shades overlap the window by at least 1 1/2" on each side. When installation has no sill, allow the shade to overlap the bottom of the window casing by at least 1 1/2". Shade fabric will measure width indicated on the order form.

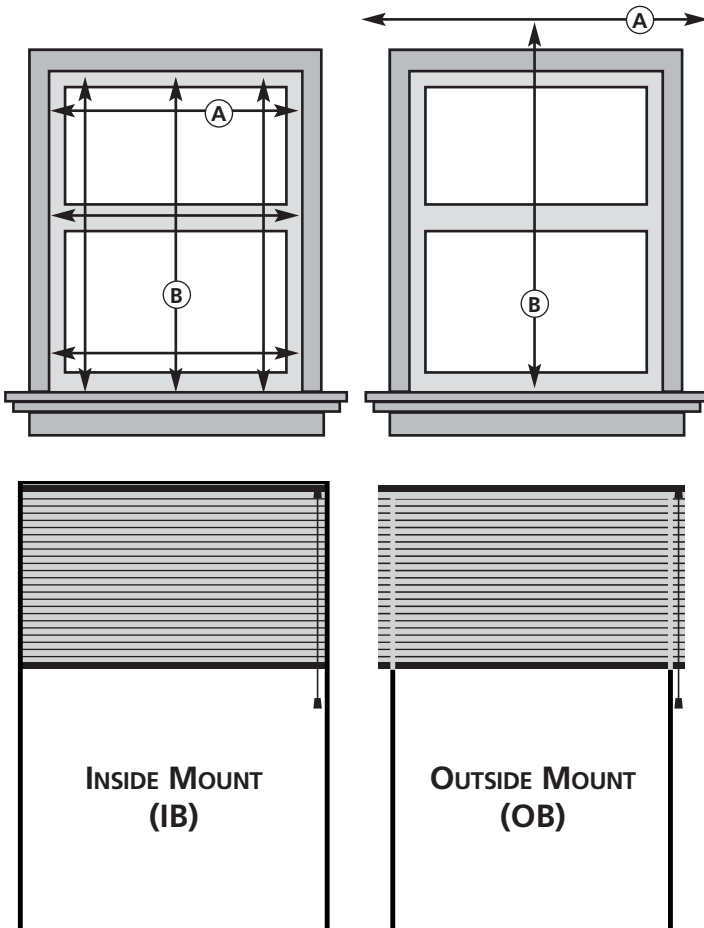

## FIVE STEPS TO AN ACCURATE TEMPLATE

1. Tape butcher paper or heavy wrapping paper over the window opening, allowing plenty of overlap. Do not use paper that has ever been folded; a template can have no folds or creases.
2. Draw an exact outline of the window opening. Do this by carefully tracing over the inside edge of the window frame.
3. Remove the paper from the window opening. If the blind is an outside mount, add the desired amount of overlap to the window outline and draw a second outline around it to match the shape of the finished blind.
4. Mark the blind dimensions on the template. Check that the template dimensions match the measurements of the actual window opening.
5. Identify the template and its orientation. Write the customer's name and PO# on the template, and mark the ROOM SIDE and TOP. Roll up the template and place it in a mailing tube.

**Do not fold the template.**

**IMPORTANT:** Template must be cut out in the exact shape of the window opening and tested in window for correct fit.

For any shade requiring a template, there will be a template surcharge of \$50 added to the price of the shade.

## ARCHES/QUARTER CIRCLES

1. For inside mounts, measure the exact width and height inside the window opening.
2. For outside mounts, measure the desired width and height.
3. Measure the height at its tallest point.
  - In *perfect* arches, height will equal one-half the width.
  - With *imperfect* arches, or eyebrows, exact height/width relationships do not occur. Extra care must be taken to ensure a good fit.
  - With quarter circles, height must equal width.

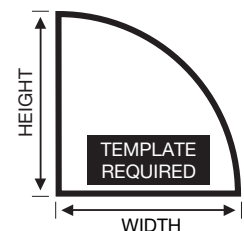
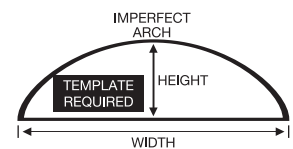
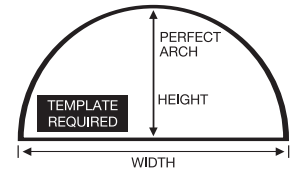



**FINISHED DIMENSIONS**

**Inside Mount:**

- Fabric will measure ordered width less: ..... 3/8"
- Headrail\* will measure ordered width less: ..... 3/16"

**Outside Mount:**

- Fabric will measure ordered width.
- Headrail\* will measure ordered width plus: ..... 3/16"

**Exact (End Cap to End Cap):**

- Fabric will measure ordered width less ..... 3/16"
- Headrail\* will measure ordered width.

\*Headrail Measurements include end caps.  
Width and Height Measurements may vary +/- 1/8".

**No Charge Options:**

- Special Cord Lengths
- Extension Brackets
- Hold Down Brackets
- Cord Cleats
- Spacer Blocks
- Side Mount

**Note on order any options required.**

**MOUNTING**

**Standard Rail:**

Minimum Shallow Mounting Surface:	1/2"
Minimum Flush Inside Mounting Surface:	2"
Minimum Outside Mounting Surface:	3/4"

**Deluxe Rail:**

Minimum Shallow Mounting Surface:	1/2"
Minimum Flush Inside Mounting Surface:	2 1/2"
Minimum Outside Mounting Surface:	3/4"

**Standard Continuous Cord System:**

Minimum Shallow Mounting Surface:	3/4"
Minimum Flush Inside Mounting Surface:	1 3/4"
Minimum Outside Mounting Surface:	1/2"

**Deluxe Continuous Cord System:**

Minimum Shallow Mounting Surface:	1"
Minimum Flush Inside Mounting Surface:	2"
Minimum Outside Mounting Surface:	1"

**Deluxe Cordless System:**

Minimum Shallow Mounting Surface:	3/4"
Minimum Flush Inside Mounting Surface:	2"
Minimum Outside Mounting Surface:	1/2"

**Ascent Motorized System: 3/8" cell size**

Minimum Shallow Mounting Surface:	5/8"
Minimum Flush Inside Mounting Surface:	2"
Minimum Outside Mounting Surface:	3/4"

**Ascent Motorized System: 3/4" cell size**

Minimum Shallow Mounting Surface:	5/8"
Minimum Flush Inside Mounting Surface:	2 1/2"
Minimum Outside Mounting Surface:	3/4"

**RAIL MEASUREMENTS**

When measuring and installing, please keep in mind the following rail measurements.

**Standard Rail:**

Depth:	1 7/16"
Height:	1/2"

**Deluxe Rail:**

Depth:	1 7/8"
Height:	1/2"

**Standard Continuous Cord System:**

Depth:	1 11/16"
Height:	1 5/16"

**Deluxe Continuous Cord System:**

Depth:	2"
Height:	2"

**Deluxe Cordless System:**

Depth:	1 11/16"
Height:	1 5/16"

**Ascent Motorized Lift System 3/8" fabrics:**

Depth:	2"
Height:	1 5/8"

**Ascent Motorized Lift System 3/4" fabrics:**

Depth:	2 1/2"
Height:	1 5/8"

**WIDTH LIMIT FOR SIDE MOUNT BRACKETS**

There is a recommended 48" width limit on shades installed with side mount brackets. End mount Ascent Motorized shades are limited to 65" in width.

**CUT OUTS**

- Cut-outs are available with all fabrics
- Cut-outs are \$50 per side and are subject to approval by the fabricator
- There are no limits on cut-out heights. There are, however, limits on cut-out widths:

Shade widths less than 18": 3" maximum cut-out

Shade widths greater than 18": 5" maximum cut-out

## STACKING HEIGHTS - STANDARD RECTANGULAR

NOTE: Drop refers to shade fully extended. Measurements do not include headrail and bottomrail. Refer to page 25 for all rail measurements.

### ARISTOCRAT

#### 3/4" SEMI-SHEER

DROP	48"	72"	84"	144"
STACK	1 1/4"	1 3/4"	2"	3 1/4"

### ARISTOCRAT

#### 3/4" BLACKOUT

DROP	48"	72"	84"	144"
STACK	1/2"	3/4"	1 1/8"	1 3/4"

### ARISTOCRAT

#### 3/8" BLACKOUT

DROP	48"	72"	84"	144"
STACK	7/8"	1 1/16"	1 5/16"	2 3/16"

### ARISTOCRAT

#### 3/4" LINEN

DROP	48"	72"	84"	144"
STACK	1/4"	1/2"	3/4"	1 1/4"

### ARISTOCRAT

#### 3/8" TEXTURES

DROP	48"	72"	84"	144"
STACK	1/2"	3/4"	1"	1 3/4"

### ARISTOCRAT

#### SOFT DOUBLE CELL

DROP	48"	72"	84"	96"
STACK	2 1/8"	3 1/8"	3 1/2"	4"

### ARISTOCRAT

#### 1/2" DOUBLE CELL

DROP	48"	72"	84"	144"
STACK	5/8"	1"	1 1/8"	2"

### ABBEY COURT

#### 3/4" SINGLE CELL

DROP	48"	72"	84"	144"
STACK	1/4"	1/2"	3/4"	1 1/4"

### ABBEY COURT

#### 3/8" SINGLE CELL

DROP	48"	72"	84"	144"
STACK	1/2"	3/4"	1"	1 3/4"

### ABBEY COURT

#### 3/8" DOUBLE CELL AND PRINTS

DROP	48"	72"	84"	96"
STACK	1 1/4"	1 3/4"	2"	2 1/4"

### ABBEY COURT

#### FLAME RESISTANT

DROP	48"	72"	84"	96"
STACK	1 1/4"	1 3/4"	2"	2 1/4"

### ANDOVER

#### 1/2" SINGLE CELL

DROP	48"	72"	84"	96"
STACK	1 1/4"	1 3/4"	2"	2 1/4"

ASCENT MOTORIZED LIFT SYSTEM OPTIONS

- Headrail is available in white and cream. Please specify when ordering. Bottom rail is color coordinated to the fabric.
- Battery wand and infrared eye within the headrail are standard. Other features are below along with associated surcharges. Please indicate any options when ordering.

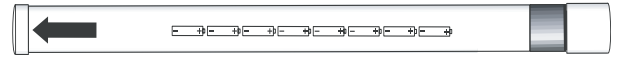

*The battery wand fits inside the headrail*

- The short battery wand, for shades up to 26" wide, uses 8 AAA batteries. The long wand, for shades over 26" wide, uses 8 AA batteries. Life of batteries is approximately 1 1/2 years depending on usage. Replace batteries when shade begins to operate slowly. Only use alkaline batteries.

Remote Control: **\$52**  
 (Purchase at least one hand-held remote control per order.)

**Satellite Eye**

The satellite eye is an external infrared eye to be used when a window treatment obstructs the headrail. Three cable lengths are available:

- Satellite Eye 20" Cable: **\$27**
- Satellite Eye 4' Cable: **\$37**
- Satellite Eye 8' Cable: **\$44**

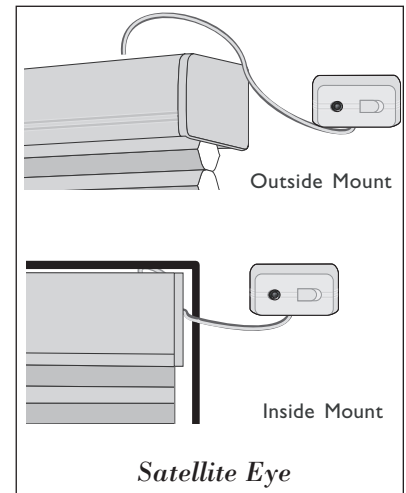

*Satellite Eye*

**Battery Pack**

The satellite battery pack will make changing batteries easier on tall or out-of-reach windows. Three cable lengths are available:

- Battery Pack 15" Cable: **\$45**
- Battery Pack 4' Cable: **\$52**
- Battery Pack 8' Cable: **\$59**

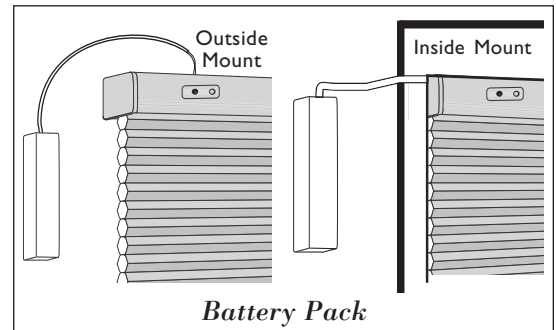

*Battery Pack*

**AC Power Adapter**

Eliminate the need for batteries by using the AC Adapter with any standard wall outlet. Three cable lengths are available:

- AC Adapter 12' Cable: **\$61**
- AC Adapter 16' Cable: **\$72**
- AC Adapter 25' Cable: **\$79**

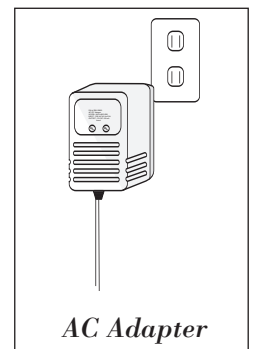

*AC Adapter*

## ASCENT MOTORIZED LIFT SYSTEM ORDERING CONSIDERATIONS

Strong sunlight or artificial light could interfere with operation of the infrared eye. It may be necessary to make adjustments in room lighting so direct light does not shine into the infrared eye.

### Distance between Infrared Eyes

- It is important to keep adequate distance between infrared eyes to avoid unintentional activation of one shade by the remote control signal intended for another shade.
- For independent shade operation, the recommended distance between infrared eyes is 48".
- Shades may be ordered with infrared eyes placed at opposite ends of adjacent headrails. Please indicate position of eye at time of ordering.

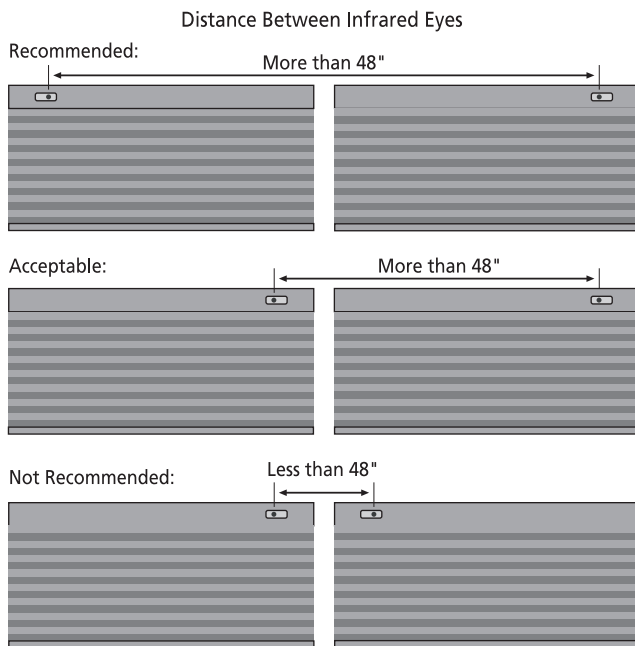

### Two-Channel Operation

- Channel 1 is standard on the remote transmitter and is normally the only channel needed.
- If the minimum of 48" separation between infrared eyes is not possible, selected shades can be set for channel 2 operation. Please specify "Channel 2" operation when ordering.
- 2 Channel operation is recommended when shades are stacked, on bay windows or on banks of shades.
- A switch at the top of the remote control is used to change from one channel to the other.

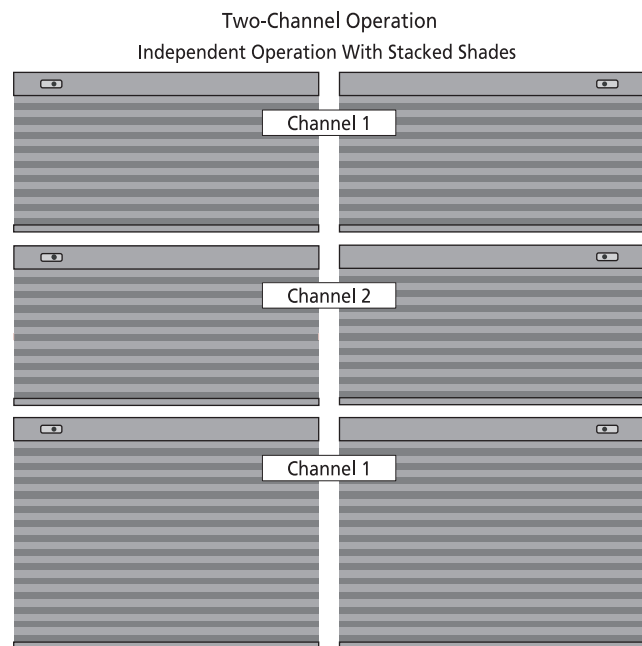

## ASCENT MOTORIZED OPERATING SPECIFICATIONS

- The distance between the remote control and the infrared eye needs to be less than 30 feet.
- Maximum headrail or satellite eye mounting height is 16 feet.
- Maximum side angle of remote beam is 45 degrees.
- Maximum upward angle of remote beam is 55 degrees.

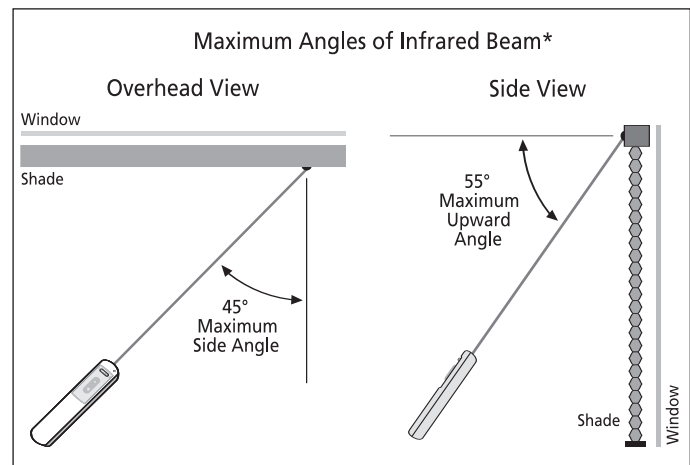

HONEYCOMB ENERGY EFFICIENCY AND LIGHT CONTROL DATA

The Kensington line of Honeycomb shades offers a wide range of insulation and light values. Depending on the application requirements, one or more of these products is sure to provide the desired level of comfort and ambiance.

FABRIC TYPE	WINTER R-VALUE DOUBLE GLAZING	SUMMER R-VALUE DOUBLE GLAZING	SUMMER SHADING COEFFICIENT DOUBLE GLAZING	% UV BLOCKAGE	LIGHT TRANSMISSION	SOUND ABSORPTION
Aristocrat Soft Double Cell*	3.30	N/A	0.25	99%	12%	N/A
Aristocrat 3/4-inch Single Cell – Blackout	5.00	4.35	0.36	99%	N/A	0.40
Abbey Court 1/2-inch Double Cell – Translucent	4.35	2.90	0.35	98%	N/A	0.55
Abbey Court 3/8-inch Double Cell – Translucent	4.60	N/A	0.38	99%	11%	N/A
Abbey Court 3/8-inch Single Cell – Translucent	3.70	2.80	0.45	99%	N/A	0.40
Abbey Court 3/4-inch Single Cell – Translucent	3.60	2.90	0.44	98%	N/A	0.55
Abbey Court Double Cell – Flame Resistant	4.34	N/A	0.27	99%	N/A	N/A
Andover 1/2-inch Single Cell – Translucent	3.20	N/A	0.45	98.7%	15%	N/A

\*Based on reported value of equivalent fabrics with duplicate cellular construction.

DEFINITION OF TERMS

**R-Values** measure resistance to heat flow. The higher the R-Value, the more insulation the product provides.

**Summer Shading Coefficient** measures the amount of heat passing through a covered window versus a bare window. The lower the number, the less heat is transferred. In summer, less heat transfer means a cooler room.

**% UV Blockage** measures the product’s effectiveness at preventing harmful ultraviolet rays from entering the home’s interior. The higher the percentage, the more UV rays are blocked.

**Sound Absorption** measures the amount of sound absorbed by the shade. The higher the number, the better the sound absorption.

# KENSINGTON

WINDOW EXPRESSIONS™

## Honeycomb Shade Order Form

Account Name: \_\_\_\_\_ Date: \_\_\_\_\_ Ship to: \_\_\_\_\_  
 Account Number: \_\_\_\_\_ Contact: \_\_\_\_\_ Address: \_\_\_\_\_  
 PO #: \_\_\_\_\_ Fax #: \_\_\_\_\_ City/State/Zip: \_\_\_\_\_  
 Sidemark: \_\_\_\_\_ Phone #: \_\_\_\_\_ Contact Phone: \_\_\_\_\_

Special Notes: \_\_\_\_\_  
 \_\_\_\_\_  
 \_\_\_\_\_  
 \_\_\_\_\_

Line # / Tag Name	Pattern/ Sku#*	Measurements in inches		Mount (IB or OB)	Control Side (L or R)	Options - Standard/Deluxe CC, Cordless, Ascent, Top-Down/Bottom-Up, Additional Options	Additional Requests	
		Width	Length				Hold Down brackets	Extension Brackets
1								
2								
3								
4								
5								
6								
7								
8								
9								
10								

\*Please note that fabric dye lots may vary slightly from order to order.

# KENSINGTON

WINDOW EXPRESSIONS™

**Longitude Honeycomb Shade Order Form**

Account Name:	Date:
Account Number:	Contact:
PO #:	Fax #:
Sidemark:	Phone #:
	Ship to:
	Address:
	City/State/Zip:
	Contact Phone:

Special Notes: \_\_\_\_\_  
 \_\_\_\_\_  
 \_\_\_\_\_  
 \_\_\_\_\_  
 \_\_\_\_\_

LINE	QTY	IB/		WIDTH	LENGTH	Stack					Fabric Color #	Valance (Alternative Wood or Aluminum) specify any custom returns, if required
		OB				Left	Right	Center	Split	Dual Panel		
1												
2												
3												
4												
5												
6												
7												

*\*Please note that fabric dye lots may vary slightly from order to order.*

