

OPTIONAL HOLD DOWN BRACKET

Optional Hold Down Brackets are mounted with the supplied screws. With the shade at its proper drop, place the pin of each Hold Down into the hole in each End Cap and mark the screw holes. Make sure the pins are level and aligned. Raise the shade, then screw the Hold Down Bracket into the mounting surface.

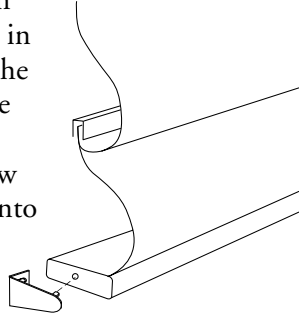

VALANCE INSTALLATION

Once the blind is installed, simply position the valance over the face of the headrail and press into place.

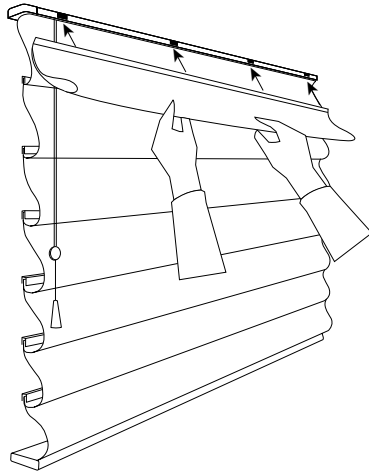

TWO-ON-ONE HEADRAIL SPLICER

For shades ordered as Two-on-One Headrail using the Splicer piece, insert Splicer in Headrail of both shades as shown. Lock into place using 3/8" Tek Screws provided.

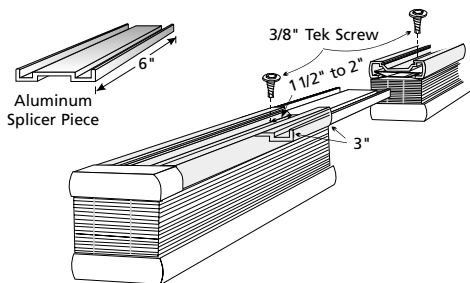

CORDLOCK OPERATION

To raise or lock shade, pull the cord down and outward toward the outside of the shade.

To lower or release the shade, pull the cord down and inward.

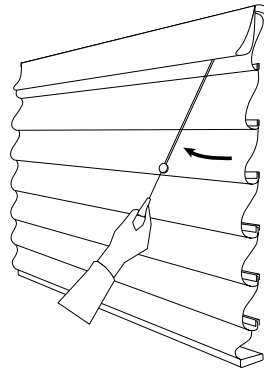

PROTECT YOUR CHILDREN

Be aware that it is possible for children to strangle in window covering cords. To reduce the occurrence of accident, all cords must be kept out of the reach of children, including infants. Cord cleats are an effective way to implement this essential precaution.

Mount the cord cleat at a safe height, taking into account furniture or other objects upon which a child may climb. Then, after each use of the shade, simply wrap the excess cord around the cleat. It's fast, easy and safe.

To protect your children, we are pleased to provide cord cleats free of charge with every shade that we manufacture.

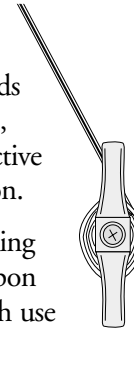

CLEANING AND CARE

Roman shades are as easy to clean as they are to operate. Roman fabrics are anti-static and actually repel dust. Occasional vacuuming with a soft bristle attachment is all that is needed. Also, the use of a feather duster or dust buster at a low setting will help keep your shades clean and fresh. Roman shades may also be cleaned ultrasonically.

KENSINGTON WINDOW EXPRESSIONS™

ROMAN SHADES

INSTALLATION INSTRUCTIONS

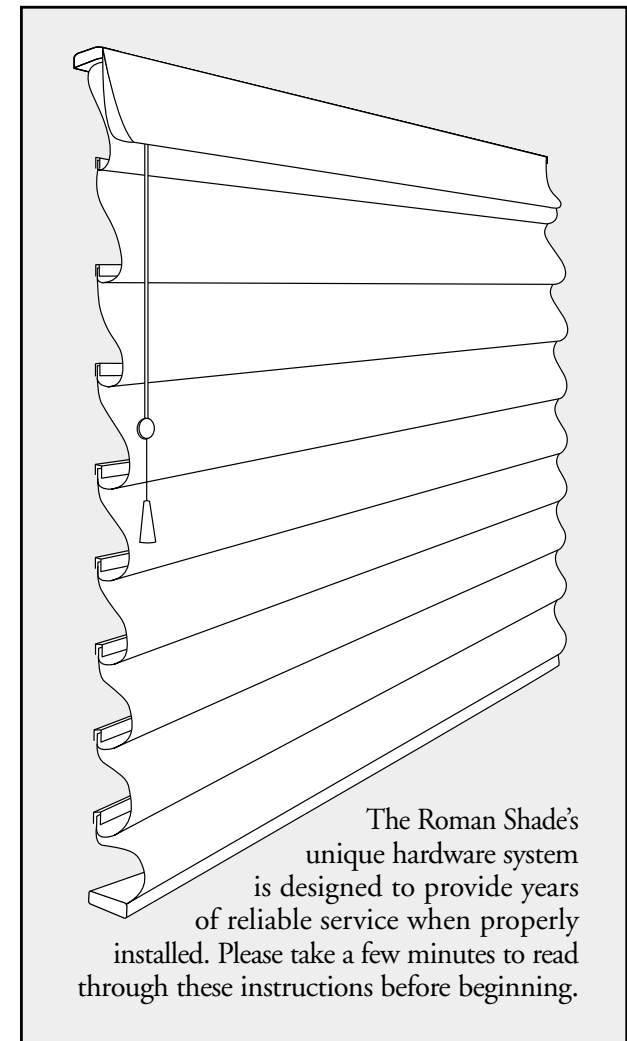

The Roman Shade's unique hardware system is designed to provide years of reliable service when properly installed. Please take a few minutes to read through these instructions before beginning.

Manufactured By



BASICS

A few simple tools are required:

- Measuring tape
- Power drill, drill bits
- Hex head and/or Phillips driver bit
- Pencil

Additional fasteners other than those sent with your shade may be required depending on the mounting surface. Wallboard and plaster require the use of anchors such as expansion or toggle bolts. Brick, tile or stone need special plugs and drill bits. Remember to always pre-drill holes in wood to avoid splitting.

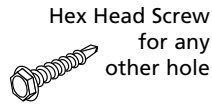
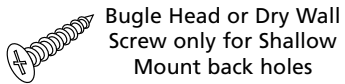

Hold Down Bracket (Optional)

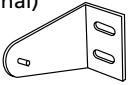

Extension Bracket (Optional)



Roman shades are constructed as either an Inside Mount or an Outside Mount. The Installation Bracket can be mounted inside the window opening, for an inside mount, or on the molding or wall above the window for an outside mount. The Extension Bracket and the Hold Down Bracket are optional items requested at the time of ordering the shade. The Extension Bracket provides projection of the Installation Bracket in order to clear obstructions. The Hold Down Bracket keeps the shade from swaying and is often used for installation on door windows.

Shallow Mount back hole

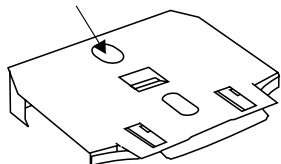

Shallow Mount back hole

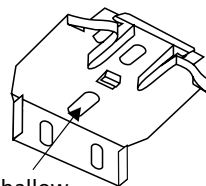

BRACKET INSTALLATION

Shades are shipped with the required number of brackets for proper installation. End brackets should be located with centerlines $2\frac{1}{2}$ " in from each end. Depending on the width of the shade, additional brackets may be necessary evenly spaced between the two end brackets.

For shade widths of:	Use this number of brackets:
Up to 40"	2
40" to 72"	3
72" to 84"	4
84" and up	5

Using the Installation Bracket as a template, measure and mark the center lines. When mounting brackets, make sure they are in line and level.

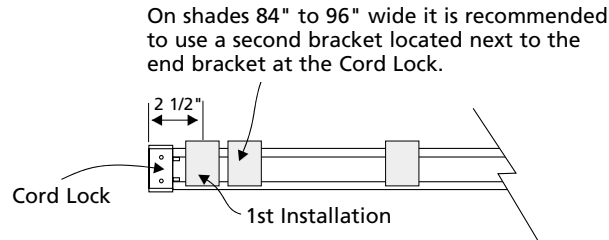

INSIDE MOUNT

The brackets are mounted flat against the top sill surface. The flat head screw should be placed through the hole closest to the front of the bracket. To fully recess the shade requires a flat surface with a minimum depth of $1\frac{3}{4}$ ". Shallow mounting requires $\frac{1}{2}$ " minimum.

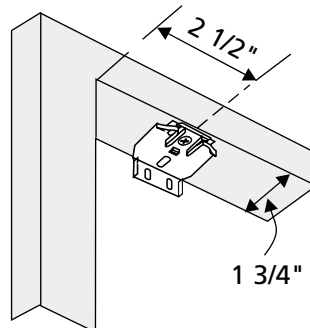

OUTSIDE MOUNT

The brackets are mounted with two bugle head screws through the back end of the bracket flat against the window molding or the wall above the window. The bracket requires a minimum $\frac{3}{4}$ " high.

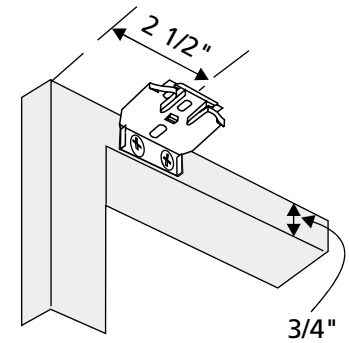

OPTIONAL EXTENSION BRACKETS

Optional Extension Brackets are used to project the back of the shade up to $2\frac{3}{8}$ " from the mounting surface. Attach the Installation Bracket to the Extension Bracket with the nut and bolt provided.

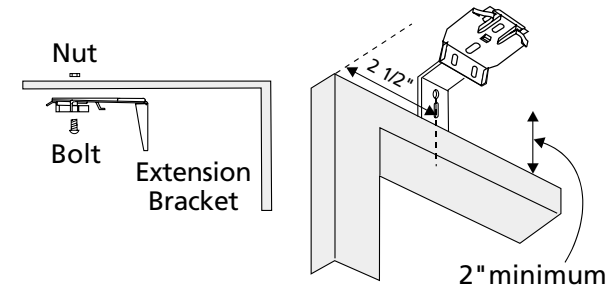

HANGING THE SHADE

Unwind the cord from the shade but keep the rubber band around the shade stack.

1. Hold the shade up near the brackets and insert the front clip of the bracket into the front groove of the rail.
2. Make sure the shade is centered in the window opening.
3. Push the rail back and up until the back clips of the bracket are inserted in the back groove of the rail.

To remove shade, reverse procedure.

