

EXTENSION BRACKETS

Extension brackets can project the installation brackets up to 2 1/2" away from the mounting surface. Position the brackets at the locations you marked and use two screws to attach them.

Be sure the tops of the extension brackets are perfectly horizontal and aligned at the same height. Connect the installation brackets with the machine screws and speed nuts which are included with each extension bracket. Be sure to use the same holes on all the extension brackets, so that each installation bracket projects the same distance from the mounting surface. Indentations are cast into the extension brackets between the holes. Before mounting an extension bracket, any unneeded length may be cut off at one of the indentations.

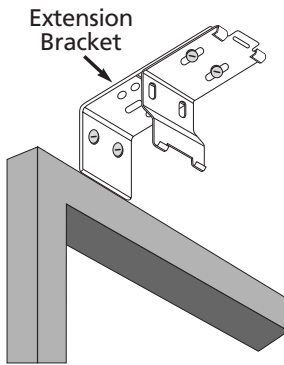

MOUNTING THE HEADRAIL

Unwind the cord from around the shade assembly and let it hang. With the front of the shade facing you, slip the headrail into the installation brackets. First, insert the back lip on the bottom of the headrail into the bottom groove on the brackets, making sure no fabric gets trapped between the headrail and the bracket. Then push on the rail until the top groove snaps into place, as shown.

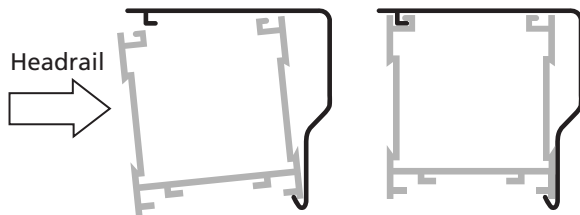

Manufactured By



© 3/01

K210

KENSINGTON WINDOW EXPRESSIONS™

HONEYCOMB CONTINUOUS CORD SYSTEM

INSTALLATION & REMOVAL INSTRUCTIONS

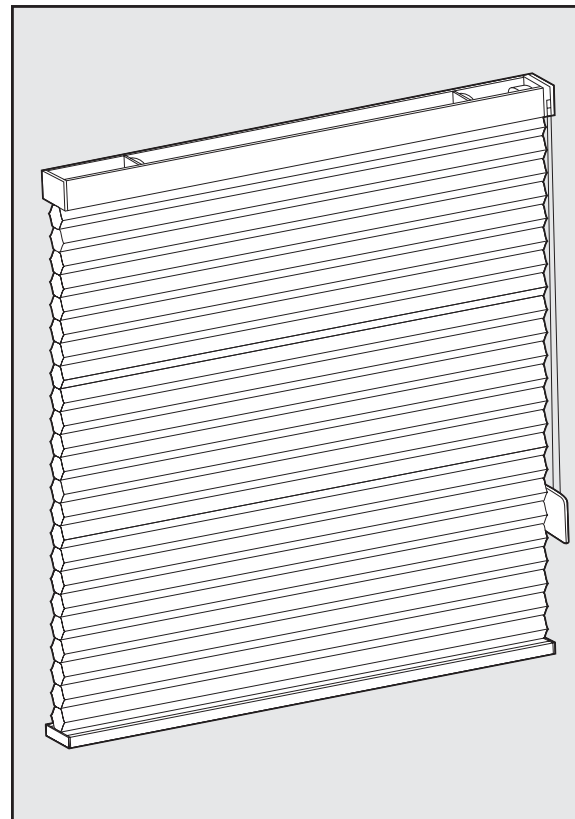

MOUNT THE BRACKETS

Mount the brackets to the wall or window frame, with the outside brackets no further than 2 inches (5 cm) from the ends of the headrail. On wide shades, space the additional bracket(s) at equal intervals.

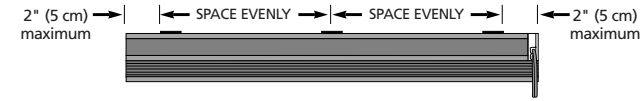

For wall or outside mounts, use the rear bracket holes.

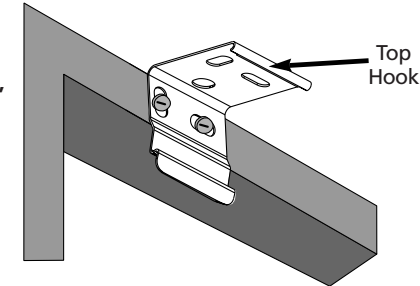

For inside or ceiling mounts, use the top bracket holes.

Note: Release tab is always the bottom of the bracket

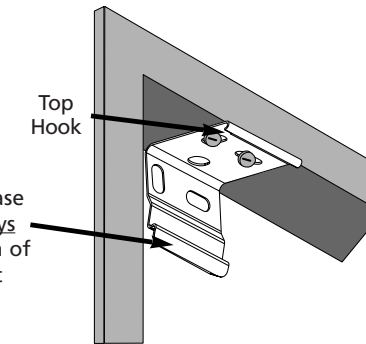

MOUNT THE HEADRAIL

First lower the shade to about an inch (2/3 cm) below the headrail. This will help keep the fabric from getting caught between the brackets and the headrail.

Position the headrail with the front lip (A) resting on the top hooks of all brackets. Make sure no fabric is pinched between the brackets and headrail.

Push the bottom of the headrail firmly upwards and toward the window until the groove at the bottom of the headrail snaps into place, (B) as shown.

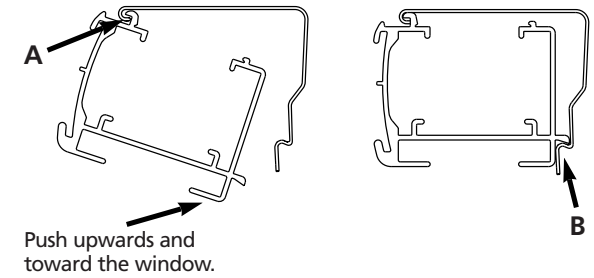

Push upwards and toward the window.

INSTALL THE TENSION DEVICE

The Tension Device reduces the hazards of strangulation and entanglement of young children by limiting access to the control cord. Anchor the Tension Device that is attached to the blind's control cord, to the window frame or wall, so that young children cannot pull the cord around their necks.

A. Lower the blind

B. Hold the Tension Device upright and position the Tension Device using one of the three methods shown.

C. Position the Tension Device so that the Tension Device and the control cord do not interfere with raising or lowering the blind. The Tension Device should be installed without stretching or pulling down on the control cord. Stretching the cord will cause excessive wear. Do not twist or cross the control cord.

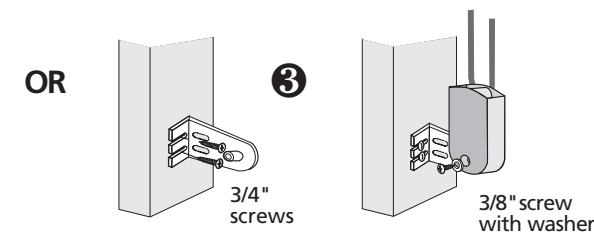
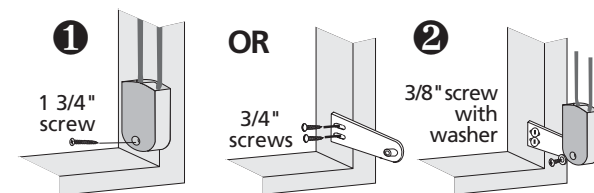

OPERATING THE SHADE

Operate the shade by pulling down on one side of the cord. One side of the cord raises the shade, the other side lowers the shade. Do not lift the bottom rail with your hands. Also, be careful not to place objects on the window sill that will interfere with operating the shade or cause it to hang unevenly.

If the shade does become crooked, simply lower it as far as it will go and then raise it again. This will ensure that all the lift lines inside the shade are pulling up evenly.

ADJUST LENGTH OR EQUALIZATION

If the shade length and equalization is satisfactory, simply trim the excess cord hanging below the bottom rail.

If adjustments are necessary, pull the excess cord at the bottom of the shade down until the Bottom Rail Plug is released (fig. A).

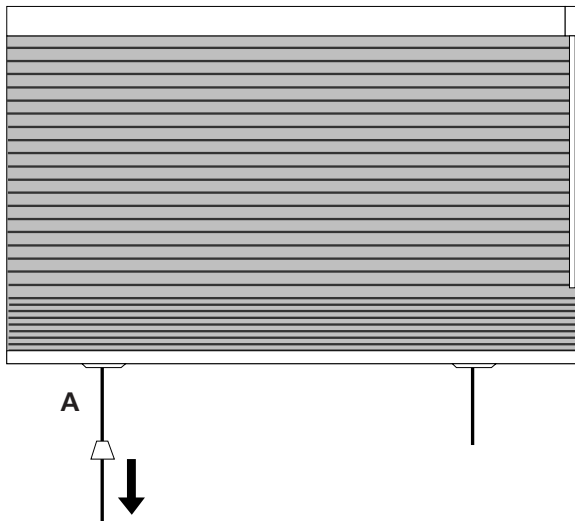

Push the cord up through the Bottom Rail Plug (figs. B & C).

Adjust the position of the plug as necessary (fig. D)

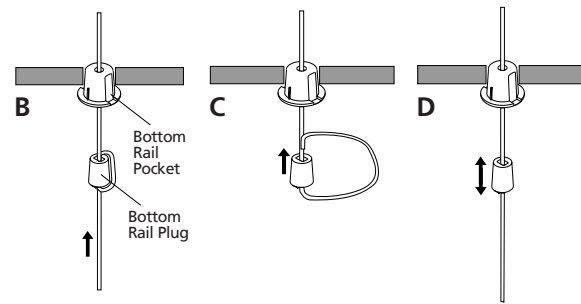

Feed the cord back through the Bottom Rail Plug (figs. E & F).

Push the Bottom Rail Plug back into the Bottom Rail Pocket.

When bottom rail adjustments have been made, trim the excess cord hanging below the bottom rail.

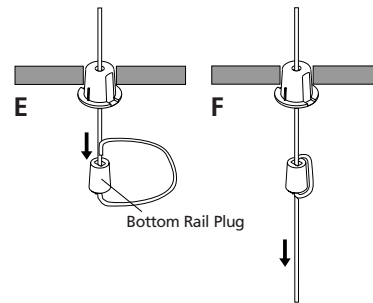

REMOVING A SHADE

To remove a shade, insert a screwdriver between the headrail and bottom back of the bracket (tab which extends out slightly from each bracket).

Gently pry the screwdriver to release the bracket from the headrail.

Take care not to damage the painted finish of the headrail.

As you release the brackets, support the headrail to keep it from falling.

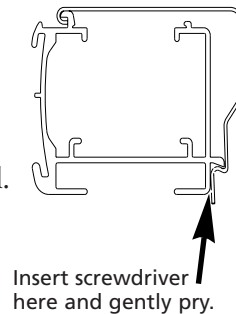

ADDITIONAL INSTRUCTIONS
for the Deluxe Continuous Cord System used with the Abbey Court 3/4" Translucent, the Aristocrat 3/4" Blackout and the Aristocrat Double Cell Translucent.

BRACKET SPACING

Bracket spacing is the same for both inside and outside mounts. Two installation brackets are positioned on the mounting surface so that their edges will be 1 1/2" in from the ends of the shade. If more than two brackets are required (see chart), additional brackets are spaced evenly between the two end brackets. Measure and mark all bracket locations.

Note: Check to be sure that no installation brackets will be positioned directly above any of the tape spools located inside the headrail.

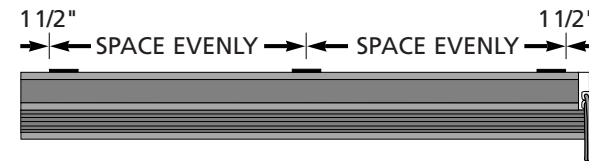

Shade Width	Number of Brackets
to 31"	2
31" to 79"	3
79" to 127"	4
127" to 174"	5

INSIDE MOUNT

To inside mount a Continuous Cord Loop shade, attach the tops of the installation brackets to the top sill of the window opening. To attach the brackets, the flat surface of the sill must be at least 1 1/4" deep. To fully

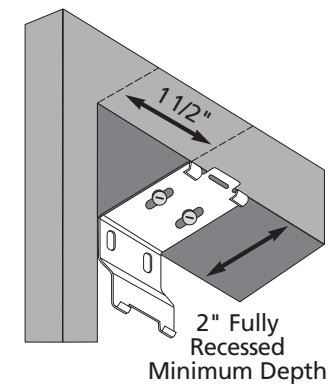

recess the shade, the flat surface must be at least 2" deep. Add to these minimum depths the dimension of any obstruction to shade movement, such as a window crank or handle. Two screws are used to attach each bracket. Mount the brackets at the locations you marked, with their front edges aligned.

OUTSIDE MOUNT

Mount the ends of the installation brackets on a flat vertical surface 1" high. Two screws are used to attach each bracket. Mount the brackets at the locations you marked. Before tightening the screws, check to be sure the tops of the installation brackets are perfectly horizontal and aligned at the same height.

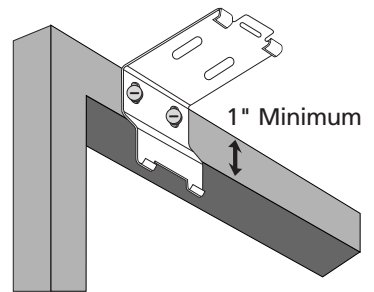

SPACER BLOCKS

Spacer blocks are used to project the installation brackets away from the mounting surface when additional shade clearance is needed. Each spacer block increases clearance by 1/2"; use a maximum of three per installation bracket. Check that your mounting screws are long enough to securely attach the installation bracket and the spacer blocks. The solid side of the blocks should face the mounting surface. As with all outside mount installations, make sure the tops of the installation brackets are perfectly horizontal and aligned at the same height.

